



Installation and Operation Manual

Models: 1.5 THP, 1.65 THP,
2.25 THP, 2.7 THP, and 3.45 THP

Catalog Numbers for THP Listing: NPTA150, NPTT165, NPTT225,
NPTT270, NPTT345, NPTQ165, NPTQ225, NPTQ270, NPTQ345

Programmable Pool Pump Motor/Control



This product does **NOT** provide a Safety Vacuum Release System (SVRS).

Save this instruction manual for future reference.

Nidec

NIDEC MOTOR CORPORATION



Table of Contents

Important Safety Information	1
Neptune® 1.50, 1.65, 2.25, 2.7, & 3.45 THP Pool Pump Motor	3
Features	3
Dimensions	4
Electrical Requirements	7
Input	7
Rated Output	8
Agency	8
Installation Instructions	9
Prepare the Pool Pump Motor for Operation	9
Wire the Pool Pump Motor	10
Wire the Auxiliary Load Relay (Optional)	12
Pump Control via the User Interface	13
Navigation Overview	13
Quick Start Guide	14
DOE Features Enabled	15
Menu Trees	16
Install Settings	18
My Pool Settings	22
DOE Features Disabled	26
Menu Trees	26
Install Settings	29
My Pool Settings	30
Timer Settings	32
Keypad Lockout	34
Enable Manual Timers	35
Clean and Override Operations	35
Pump Control via the DI Board	36
Discrete Switch Inputs	36
RS-485 Port	38
Protections	40
Motor Protection	40
Hardware Protection	41
Mechanical Requirements	41
Environmental Requirements	41
Troubleshooting	42
Basic Troubleshooting	42
General Troubleshooting	43
Fault Conditions	44
Maintenance	48
Lower Your Utility Costs	48
Example Calculations	48
Default Settings	49
Index	51
Warranty Information	52
Notes	53

Important Safety Information

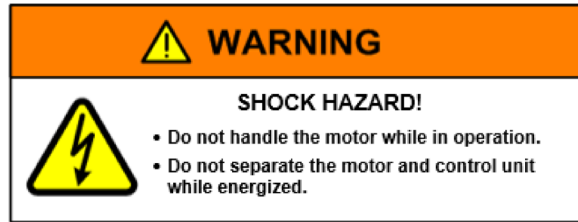

WARNING

- Read all instructions thoroughly and be familiar with the equipment before installing or working on it.
- **DO NOT** lift the pool pump motor by the control unit.
- Before connecting or disconnecting cables or other electrical connections, verify that the electrical power to the system is removed. Failure to comply may cause serious damage to the pool pump motor or pump system or injury.
- There are no serviceable parts in the pool pump motor or control.
- Because of the risk of electric shock, only individuals thoroughly trained in the use of multi-meters should conduct electrical tests.
- Never touch the metal contacts on the multi-meter during a test.
- Always check testing equipment for proper operation before use.

WARNING

Installation, operation, and maintenance must be performed by qualified personnel. Familiarization with and adherence to the National Electrical Code (NEC), the National Fire Protection Association (NFPA) standards and to local codes are required. It is important to observe safety precautions to protect personnel from possible injury. Personnel should be instructed for handling each of the following:

- Insulate all connections carefully to prevent grounding or short circuits. Reinstall all conduit and terminal box covers.
- To avoid overheating, voltage to the motor control must be within $\pm 10\%$ of the nameplate voltage.
- Make sure the unit is electrically grounded and that proper electrical installation, wiring, and controls are used consistent with local and national electric codes. Refer to the **NEC Handbook and NFPA No. 70**. Employ qualified electricians for the installation and maintenance of the unit.
- Code requirements differ from state to state. Install equipment using qualified electricians in accordance with the applicable codes and ordinances in your area and in accordance with the NEC. All electrical connections should be made and maintained by a qualified or licensed electrician.
- Make sure there are no unusual noises or vibrations when the pool pump motor is running.
- Avoid contact with energized circuits and rotating parts.

Neptune® 1.5, 1.65, 2.25, 2.7, & 3.45 THP Pool Pump Motor

WARNING

- Always disconnect electrical power at the fuse box or circuit breaker panel before handling electrical connections or performing maintenance on this unit. Allow the pool pump motor to come to a complete stop and wait three (3) minutes. This allows the capacitors to discharge any residual voltage for safety.
- All aspects of the installation must conform to the applicable requirements of the NEC, including **Article 430 (Motor Circuits and Controllers)**, as well as all local codes.
- Double-check to make sure that electrical power is removed and that it cannot be turned on while you are working on the equipment.
- A poor electrical connection can overheat and cause terminal and/or terminal board failures. Examine the connections carefully for any signs of physical deterioration or loose fit to the motor terminal block.
- Care must be taken to assure connections are made to the proper terminals and adequate electrical clearances are maintained.
- The control unit on the pool pump motor contains hazardous voltage.

CAUTION

- Wear safety glasses to inspect the equipment while it is running or while working on equipment.

NOTICE

The pool pump motor and control unit are assembled and calibrated as a set. There are no serviceable parts in the motor or control.

- To prevent permanent damage to the unit, **only apply nameplate voltage**.
- **DO NOT** strike the pool pump motor shaft with a hammer or other tool as this may cause damage.
- Voltage symbols vary among different multi-meters and may be displayed as Vac, AC, V, or a V beneath a wavy line. Select the correct symbol and set the multi-meter to the voltage closest to but higher than the voltage you are measuring.
- Although designed for outdoor application, the pool pump motor is properly packaged for shipment and storage and should be kept in a clean and dry indoor area until installed for use.

Neptune® 1.50, 1.65, 2.25, 2.7, & 3.45 THP Pool Pump Motor

The Neptune® 1.50 - 3.45 Total Horsepower (THP) Variable Speed Pool Pump Motor is a premium efficient product that includes a fully integrated motor, control, and User Interface (UI). The product delivers programming flexibility and exceptional speed range capability. It is also designed to communicate and operate with a variety of external system controls, in addition to the on-board UI.

The Neptune® 1.5 - 3.45 Variable Speed Pool Pump Motor is compliant with all July 2021 Department of Energy (DOE) energy-efficiency standards and regulations.

Features

- Total Output Horsepower (THP): 1.50, 1.65, 2.25, 2.7, & 3.45 THP at 3450 RPM, variable speed
- Input Voltage/Hertz: Single phase, 115 and 230 Vac, 50 or 60 Hz
- Automatic Voltage Sensing on Dual Voltage Models
- Power Factor Correction: 94-97%
- Speed Range: 600-3450 RPM
- Nominal Efficiency (at 3450 RPM): 1.50 & 1.65 THP is 81%; 2.25, 2.7, & 3.45 THP is 85%.
- Enclosure: Finned Aluminum enclosure providing a Water Ingress Protection level of IPX5 for long field life in outdoor environmental conditions
- Frame: Square Flange, C-Flange, Thru Bolt with Base
- User Interface: Fully functional, easy to operate, capable of 90°, 180°, or 270° rotation
- Motor Rotation: Counter-clockwise (CCW), viewing motor shaft
- Low Temperature Monitor: Threshold temperature configurable in the UI
- Fully Integrated: Designed for simple “Drop-In” installation with no complex wiring
- Auxiliary Load Relay, max load pass-through, 8/16 amps @ 230/115 Vac
- Capable of communicating with specific pool control systems via MODBUS RTU, discrete input voltage, 9-30 Vac/Vdc
- Capable of setting up to seven daily schedules
- Adjustable priming time & speed
- Keypad lockout
- Designed for quiet operation
- UL 1081 approvable



Square Flange



C-Flange



Thru Bolt with Base

Neptune® 1.5, 1.65, 2.25, 2.7, & 3.45 THP Pool Pump Motor

Dimensions

Square Flange

All dimensions are in inches and for reference only.

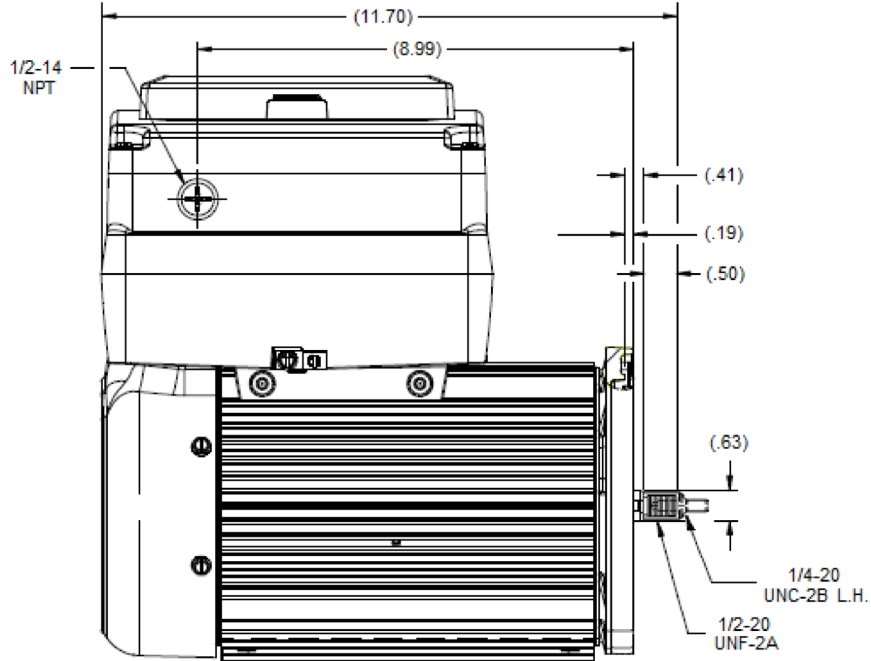

Side View

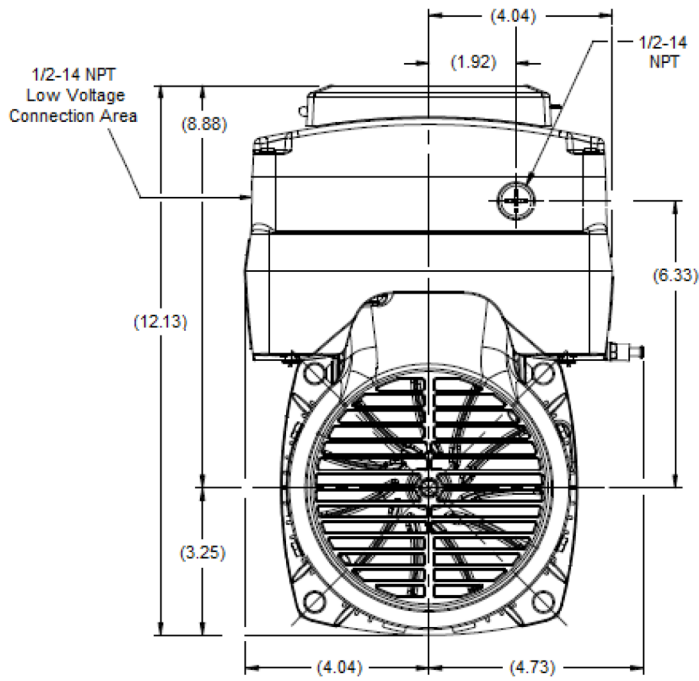

Fan View

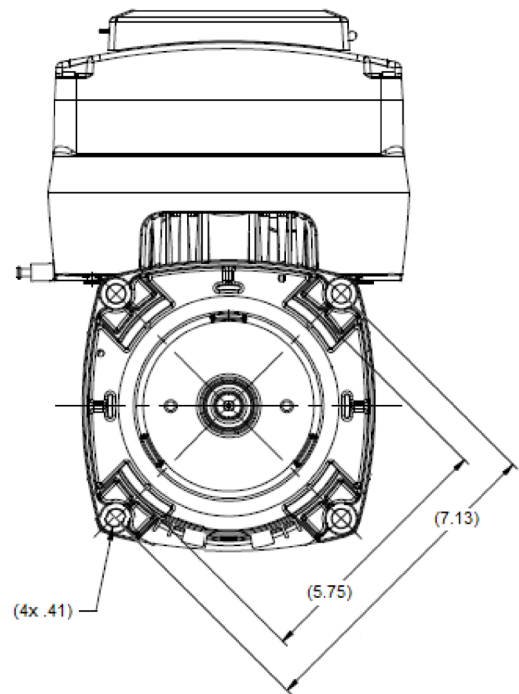

Shaft View

Neptune[®] 1.5, 1.65, 2.25, 2.7, & 3.45 THP Pool Pump Motor

Thru Bolt with Base

All dimensions are in inches and for reference only.

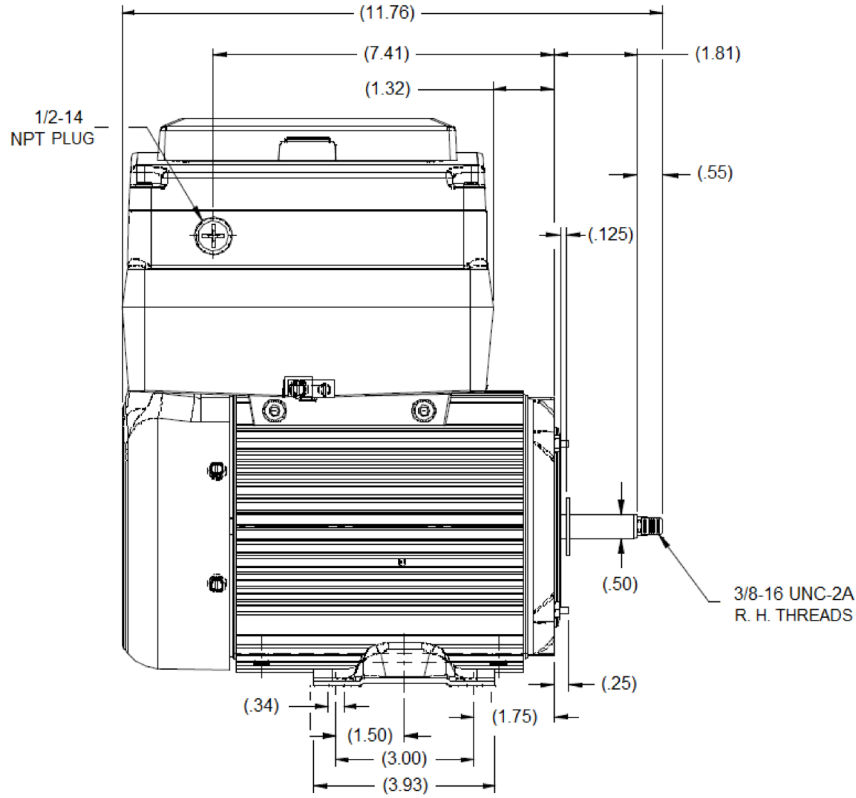

Side View

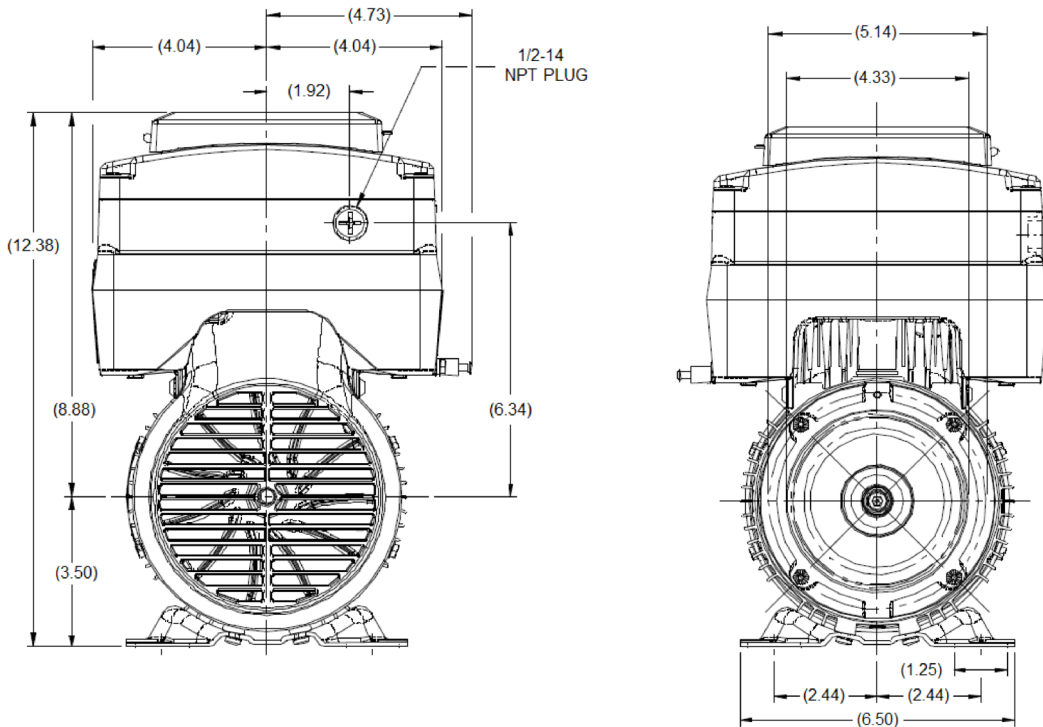

Fan View

Shaft View

Electrical Requirements

The 1.50 & 1.65 THP are Dual Voltage Models (115 or 230 Vac) while the 2.25 THP 2.7 THP, & 3.45 THP are Single Voltage Models (230 Vac only). Voltage selection is automatic. On Dual Voltage Models, the control senses the input line voltage and operates the pool pump motor at the applied input voltage.

Input

Input Line Voltage

The unit is intended to be operated from a 115 or 230 Vac (1.50 and 1.65 THP only), single phase power supply. The input AC supply frequency is 50 or 60 Hz nominal. Full rated output power is supplied between the Minimum Full Performance Voltage and the Maximum Operating Voltage. The unit operates with frequency variations up to $\pm 10\%$ of the nominal value.

Line Input \emptyset	Minimum Full Performance Voltage	Maximum Operating Voltage
115 Vac	104 Vac	127 Vac
230 Vac	208 Vac	254 Vac

Input Line Current (Amperage)

Full load AC line currents are listed below. The control limits the inrush current to less than 150A peak surge. The duration is less than 5 milliseconds.

AC Input	Total Horsepower	Full Load Current
115 Vac	1.50	13.0 Amps
230 Vac		6.5 Amps
115 Vac	1.65	13.6 Amps
230 Vac		6.8 Amps
230 Vac	2.25	9.5 Amps
230 Vac	2.70	11.1 Amps
230 Vac	3.45	14 Amps

Input Power Factor

There is a power factor correction circuit on the motor control board. Power factor range is normally 94 to 97%.

Input Power

“Power Consumed” is displayed numerically in the UI while the motor is running in any programmed mode. The unit of consumption is in watts, and an **estimate only**. For an actual and accurate power consumption measurement, an appropriate multi-meter with that specific measurement capability must be used.

Neptune® 1.5, 1.65, 2.25, 2.7, & 3.45 THP Pool Pump Motor

Rated Output

The unit is rated for the following maximum torque outputs:

1.50 THP	1.65 THP	2.25 THP	2.70 THP	3.45 THP
27 in-lb	30 in-lb	41 in-lb	49.2 in-lb	63 in-lb
600-3450 RPM				

Agency

UL File Number:

- E255002 (motor and control)
- E97751 (control)

Safety Standards

Document	Description
UL 60730-1	Automatic Electrical Controls for Household and Similar Use – General Requirements
UL1004-1	Rotating Electrical Machines – General Requirements
UL1004-3	Thermally Protected Motors
UL1004-7	Electronically Protected Motors
UL1081	Swimming Pool Pumps, Filters, and Chlorinators
CSA C22.2, No. 77	Motors with Inherent Overheating Protection
CSA C22.2, No. 100	Motors and Generators
CSA C22.2, No. 108	Liquid Pumps

Installation Instructions

Follow these instructions to prolong the life of the pump motor and control. Install the product on a secure and level platform or base, such as a concrete pad.



Installation, operation, and maintenance must be performed by qualified personnel. Familiarization with and adherence to the National Electrical Code (NEC), the National Fire Protection Association (NFPA) standards and to local codes are required. It is important to observe safety precautions to protect personnel from possible injury.

- Code requirements differ from state to state. Install equipment using qualified electricians in accordance with the applicable codes and ordinances in your area and in accordance with the NEC. All electrical connections should be made and maintained by a qualified or licensed electrician.

Protect against Heat

- Shade the motor/control from the sun.
- Provide ample cross ventilation.
- Protect the motor/control from lint, etc., which can clog the ventilation openings.

Protect against Dirt

- Keep the motor/control and the surrounding area clean.
- Avoid sweeping or stirring dust near the motor/control while it is running.
- Avoid storing or spilling dry chemicals near the motor/control.

Protect against Moisture

- Provide protection for the motor/control from rain, snow, etc.
- **DO NOT** wrap the motor/control with plastic or other air-tight materials.
- Locate the motor/control on a slight elevation so that water **DOES NOT** run or puddle nearby.
- Avoid splashing water on or near the motor/control.
- Repair leaky pipe joints or pump seals promptly.

Prepare the Pool Pump Motor for Operation

The pool pump motor has been functionally tested prior to shipment. Most pool installations already have the electrical power in conduit. However, on-site installation requirements and electrical codes vary widely and are the responsibility of the installer. The unit must be wired before operating.

Note: An electrical power cable is **NOT** provided.

You will need the following tools:

- 1/4" socket or nut driver
- Flathead screwdriver
- 5/16" Allen wrench

Neptune® 1.5, 1.65, 2.25, 2.7, & 3.45 THP Pool Pump Motor

Wire the Pool Pump Motor

The 1.50 & 1.65 THP pool pump motors are Dual Voltage Models (115 or 230 Vac), while the 2.25, 2.7, & 3.45 THP are Single Voltage Models (230 Vac only). Voltage selection is automatic on the Dual Voltage Models. The control senses the input line voltage and then operates the pool pump motor at the applied input voltage.

WARNING

- Before connecting or disconnecting cables or other electrical connections, verify that the electrical power to the system is removed. Failure to comply may cause serious damage to the pool pump motor or pump system or injury.
- Always disconnect electrical power at the fuse box or circuit breaker panel before handling electrical connections or performing maintenance on the motor. Allow the motor to come to a complete stop and wait three (3) minutes. This allows the control bus capacitors to discharge any residual voltage.
- The control unit on the motor contains hazardous voltage.

Follow the steps outlined below to wire the motor.

1. Remove the four (4) slotted head hex washer screws securing the **User Interface Cover** to the wiring compartments. Set the cover aside.

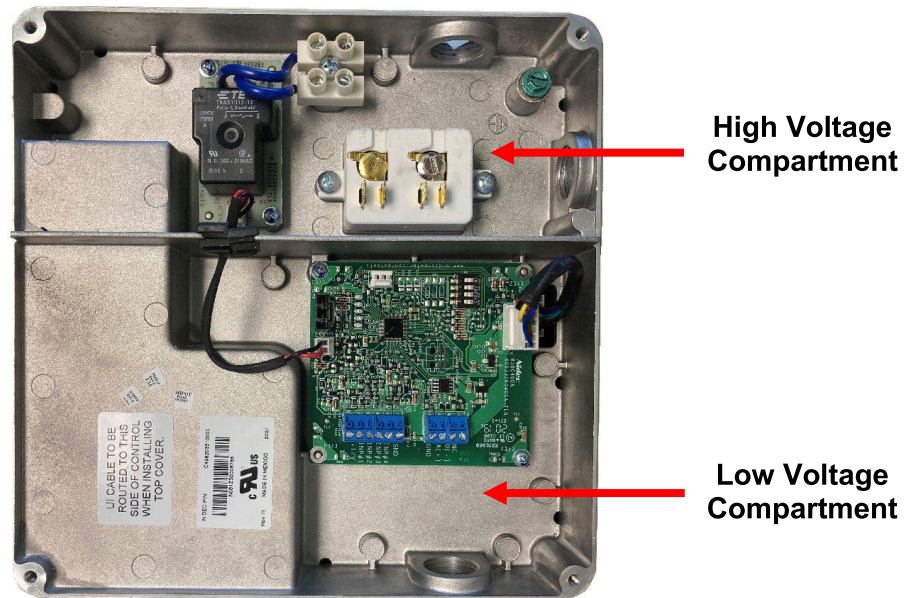

High and Low Voltage Compartments

2. On Dual Voltage Models, voltage selection is automatic. The control senses the input line voltage and operates the pool pump motor at the applied input voltage. No action is required.
3. Remove the conduit plug on the side of the **High Voltage Compartment**.

Neptune® 1.5, 1.65, 2.25, 2.7, & 3.45 THP Pool Pump Motor

4. Insert the power cable and use a water-tight connector to seal the conduit hole (1/2-14 NPT thread).
5. Install the **AC** and **Ground** power input wires as specified on the motor nameplate. You must connect **L1**, **L2**, and **GND** (Green Screw) in the wiring compartment correctly and securely.

Note: While voltage selection is automatic on Dual Voltage Models, the AC Terminal Block is to be wired differently for 115 Vac and 230 Vac. (See the two diagrams below).

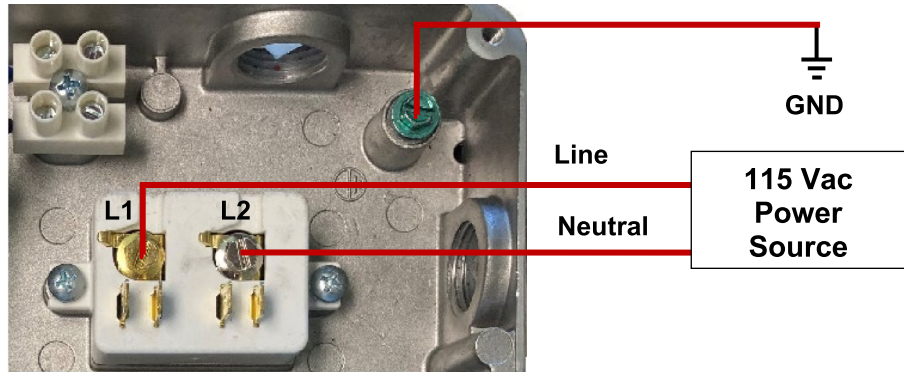

AC Terminal Block Wiring for 115 Vac

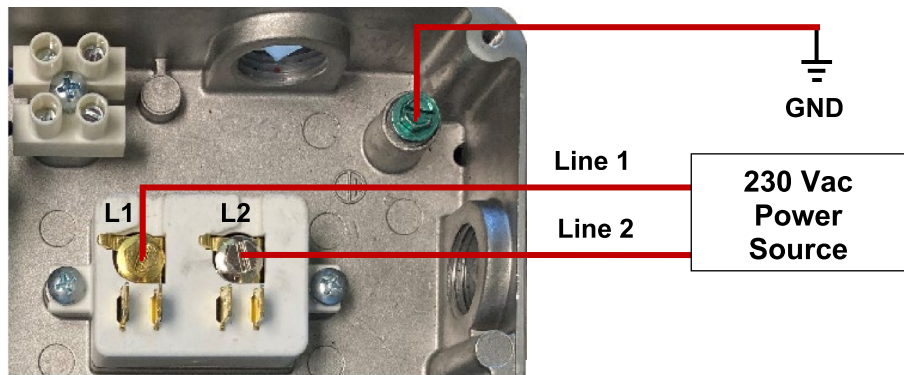

AC Terminal Block Wiring for 230 Vac

6. Ensure that the cable connecting the UI to the DI Board is routed safely on the side of the **Low Voltage Compartment** only.
7. Set the User Interface Cover back in place and secure the **User Interface Cover** tightly with the four (4) hex screws.
8. Apply electrical power. You can now begin programming the pool pump motor.

Wire the Auxiliary Load Relay (Optional)

The Auxiliary Load Relay automatically closes when the pool pump motor is operating at 2100 RPM so that you can activate an external pool accessory that is dependent on a specific flow rate, e.g., a chlorine generator, pool heater, or cleaner. Max load is 16.0 amps @ 115 Vac, or 8.0 amps @ 230 Vac.

Note: The 2100 RPM for automatic closure of the Auxiliary Load Relay is **NOT** adjustable.

1.50 & 1.65 THP Dual Voltage Models Only

There are two voltage options when operating the 1.50 or 1.65 THP pool pump motor. In this case, the motor can operate on either 115 or 230 Vac. The voltage selection is automatic. The control senses the input line voltage and operates the pool pump motor at the applied input voltage.

The wiring schematic for the Auxiliary Load Relay on the 1.50 or 1.65 THP Dual Voltage Models is as follows.

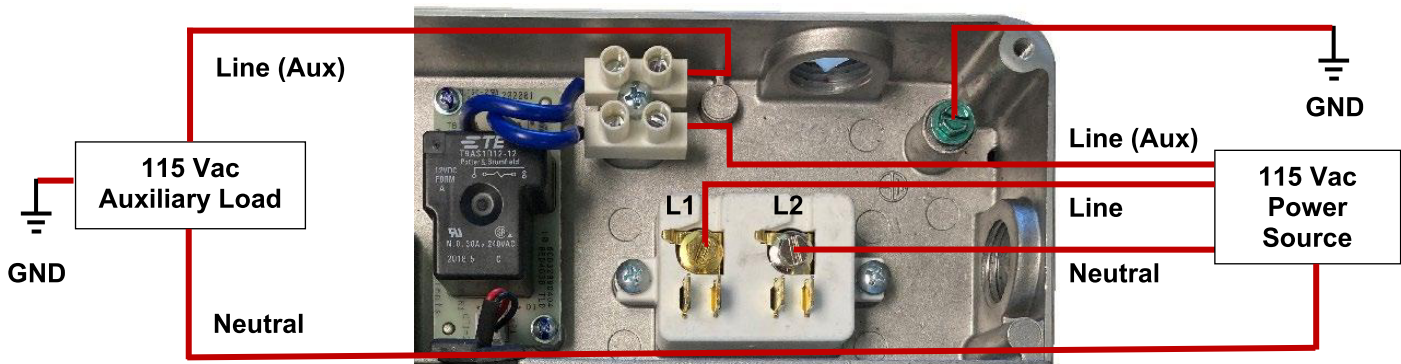

Auxiliary Load Relay Wiring, 115 Vac Power

1.50 & 1.65 THP Dual Voltage Models, 2.25, 2.7, & 3.45 THP Single Voltage Models

There are two voltage options when operating the 1.50 & 1.65 THP pool pump motor. In this case, the motor can operate on either 115 or 230 Vac. The voltage selection is automatic. The control senses the input line voltage and then operates the pool pump motor at the applied input voltage.

Operating the pool pump motor at 2.25, 2.7, & 3.45 THP requires 230 Vac electrical power. The voltage selection is automatic. The wiring schematic for the Auxiliary Load Relay is as follows.

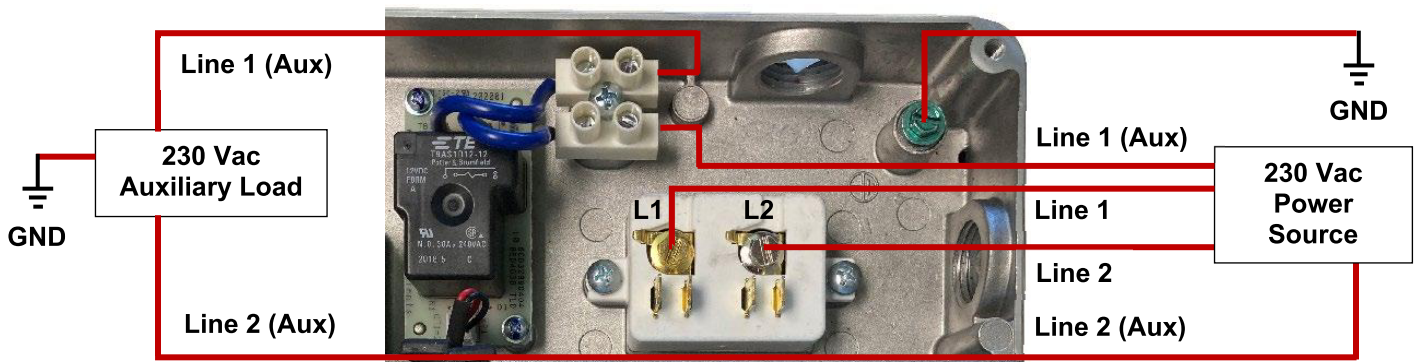







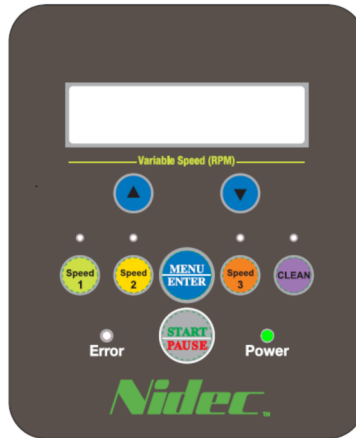



Auxiliary Load Relay Wiring, 230 Vac Power

Pump Control via the User Interface

The User Interface (UI) enables you to program the operation of the pool pump motor. Generally, the buttons have two functions. **Navigation Mode** allows you to move back and forth between the different menus and settings. **Input Mode** allows you to customize the settings and confirm your selections.



Navigation Overview

	Scroll Up – In Navigation Mode , scroll up to the previous screen. In Input Mode , increase the value of the digit in the LCD display.
	Scroll Down – In Navigation Mode , scroll down to the next screen. In Input Mode , decrease the value of the digit in the LCD display.
	Speed 1 – In Navigation Mode , there is no response. Likewise, in Input Mode , there is no response. In Run Mode , force an override using the pre-assigned Speed 1 default RPM.
	Speed 2 – In Navigation Mode , there is no response. Likewise, in Input Mode , there is no response. In Run Mode , force an override using the pre-assigned Speed 2 default RPM.
	MENU/ENTER – When the menus are unlocked, in Navigation Mode , enter a sub level menu or move to Input Mode . In Input Mode , confirm the latest setup and move back to Navigation Mode .
	Speed 3 – In Navigation Mode , there is no response. Likewise, in Input Mode , there is no response. In Run Mode , force an override using the pre-assigned Speed 3 default RPM.
	CLEAN – Start a 30-minute manual cleaning cycle at maximum speed, which is 3450 RPM (100% flow).
	START/PAUSE – In Navigation Mode , exit a menu and enter Standby Mode , or return to Navigation Mode from a sub menu. In Input Mode , exit a menu screen and return to Navigation Mode . In Run Mode , pause or restart the pool pump motor.
	Error – A flashing red light indicates the pool pump motor encountered an error. Refer to the Fault Conditions section of the manual on page 44 for additional information.
	Power – A solid green light indicates the pool pump motor is powered on and working (running either DOE Schedules or Timer cycles). A flashing green light indicates the motor has electrical power but is paused (not allowed to run).

Note: For definitions of the different **Operational States**, see **page 34**.











Neptune® 1.5, 1.65, 2.25, 2.7, & 3.45 THP Pool Pump Motor

Quick Start Guide









The Neptune® 1.50 - 3.45 THP Variable Speed Pool Pump Motor ships with a Quick Start Guide attached to the inside cover of the User Interface lid. If it is missing, the Quick Start guide is replicated here.

NEPTUNE® QUICK START GUIDE

Set the Time of Day:

1. Press  to view Main Menu options. Press  to select **Install Settings**.
Press  to enter the menu.
2. On the **Time of Day** screen press  to edit the **Hour, Minutes, and AM/PM** setting.
3. Press  /  to increase or decrease each value. Press  to save the changes.
Press  and cycle to the **24H or AM/PM** screen. Press  to edit the setting.
Press  to select your option. Press  to save the changes.

Set the Pool and Pump Capacity:

1. Press  and cycle to the **Pool Capacity** screen. You have two options.
Press  and select **Manual** to enter the pool capacity in gallons.
Or select **Calculate** and have the motor calculate the volume of water in the pool.
Press  to save the changes.
2. Press  and cycle to the **Pump Capacity** screen. You have two options.
Press  and select **Manual** to enter the pump capacity in GPM (at 100% speed).
Or select **Estimate** and have the motor **Calculate** the GPM based on your total horsepower selection.
Refer to the THP listed on the motor nameplate.
Press  to save the changes. Press  and cycle out of the menu.
3. Press  twice to return the motor into normal operation mode.

The Neptune® motor now powers the pump to properly filter the water and run in an energy-efficient manner.

Installer Information

**Scan QR Code
for full manuals**



Interface Buttons

The following navigation with the Interface buttons applies to any of the menu trees when the pool pump motor is in **Standby Mode** and the menus are **Unlocked**.

1. Press the **MENU/ENTER** button once to enter **Navigation Mode**.
2. Press **Scroll Up** or **Scroll Down** to select the menu tree.
3. Press **MENU/ENTER** to enter the menu tree.
4. Press **Scroll Up** or **Scroll Down** and cycle to a specific screen.
5. Press **MENU/ENTER** again to enter **Input Mode**.
6. Press **Scroll Up** or **Scroll Down** to adjust parameters as needed.
7. Press **MENU/ENTER** to save the changes.
8. Press **Scroll Down** to cycle to the next menu screen.
9. Press **START/PAUSE** to exit the menu screen and return to the menu tree in **Navigation Mode**.
10. Press **START/PAUSE** again to return to normal operations.

DOE Features Enabled

Dedicated Purpose Pool Pump (DPPP) regulations are aimed to achieve improved energy efficiency and are being driven by the Department of Energy (DOE). These regulations state that self-priming filtration pumps past a certain horsepower threshold—whether residential or commercial—must meet an established performance standard. These new minimum efficiency standards took effect July 18, 2021.

The Neptune® 1.50 - 3.45 Total Horsepower (THP) Variable Speed Pool Pump Motor is designed for the latest DOE Energy Rule, to minimize energy use and cost while still cleaning the pool.

The motor/control ships with the DOE Features Enabled. The default menu settings for the **DOE Features Enabled** are listed on **page 49**.

There are two top-level menus in **DOE Mode: Install Settings** and **My Pool Settings**. Configurable parameters under each menu allow you to adjust the DOE settings based on the characteristics of your specific pool.

Note: When the DOE features are enabled, all manual timers and related settings are disabled. The DOE scheduling has to be disabled to use Manual Timers and settings.

The illustrations of the two menu trees are found on the next two pages.

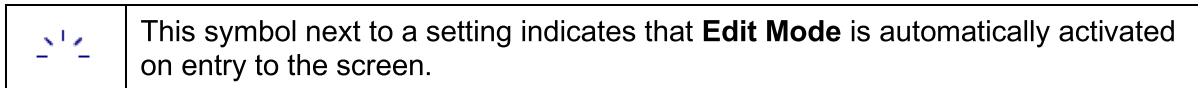

Install Settings

When enabled, the **Install Settings** allows you to set the **Time of Day** on the pool clock, adjust the DOE Scheduling built into the pool pump motor to fit your specific pool. You can calculate **Pool Capacity** based on **Pool Shape, Average Pool Length, Width, and Depth**. The settings also allow you to adjust the DOE settings for both **Pool** and **Pump Capacity** and fine-tune three (3) of the four (4) **DOE Speed** settings, if needed.

My Pool Settings

When enabled, these settings allow you to specify typical configurations like **Temp Unit, Priming Time** and **Speed**, enable **Low Temp Monitor** and **Temp** threshold, and indicate **Low Cost Start Time**. You can also disable the DOE Scheduling through this menu tree.

Neptune® 1.5, 1.65, 2.25, 2.7, & 3.45 THP Pool Pump Motor

Menu Trees

Install Settings

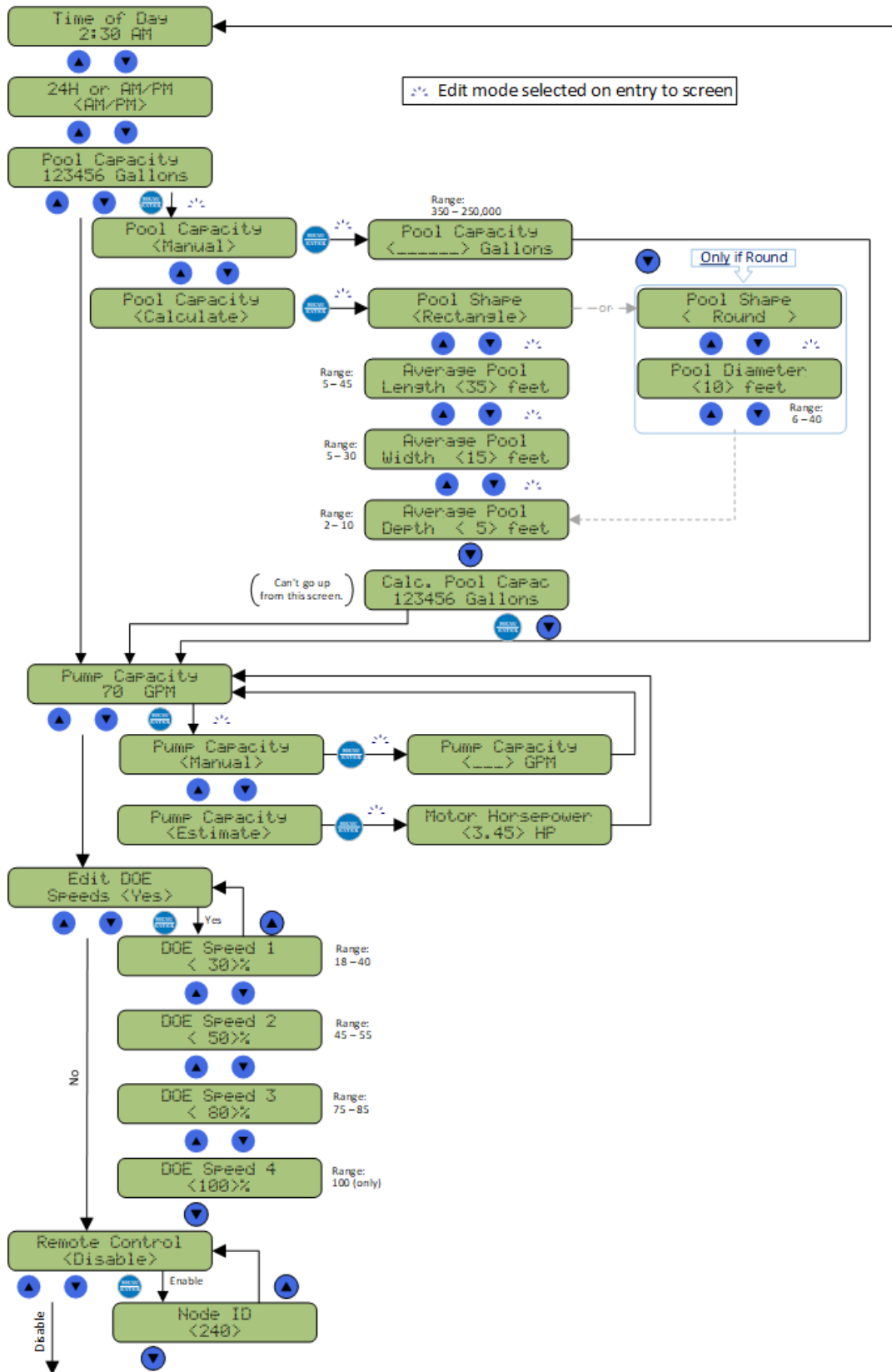

Neptune® 1.5, 1.65, 2.25, 2.7, & 3.45 THP Pool Pump Motor

My Pool Settings

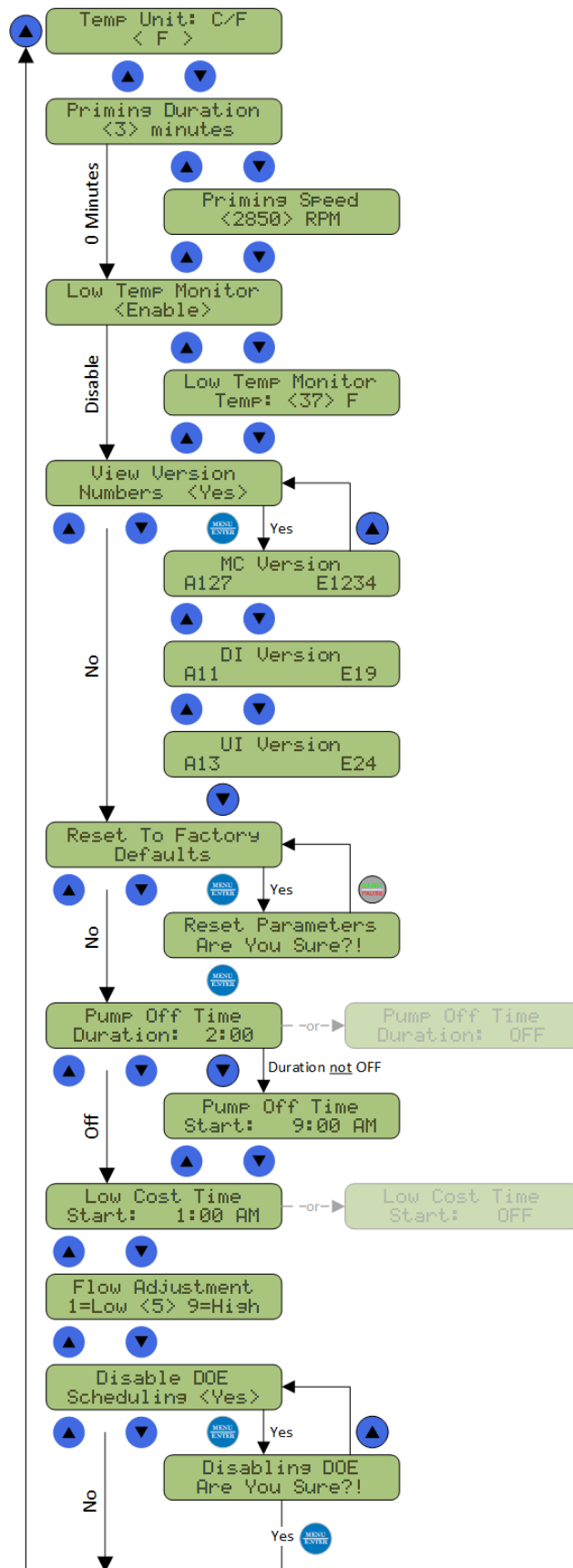

Neptune® 1.5, 1.65, 2.25, 2.7, & 3.45 THP Pool Pump Motor

Install Settings

Begin the programming of the pool pump motor from this menu. The control compares the time of day you enter here against programmed functions to determine the next pump operation.

Note: The navigation features described below are specific to each screen option. For general navigation, refer to the **Interface Buttons** on **page 14**. After adjusting a value, you must press **MENU/ENTER** to save the changes.

Time of Day

Pump activity is keyed to this setting.

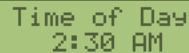

Time of Day
2:30 AM

Press **Scroll Up** or **Scroll Down** to adjust the field blinking in the LCD display. Press **MENU/ENTER** to cycle the edit field to the right. Press **Scroll Up** or **Scroll Down** to increase or decrease the **Hours**, **Minutes**, and adjust the **AM/PM** field.

24H or AM/PM

You can configure the pump to display time in a **24-Hour** clock or 12-Hour **AM/PM** format.

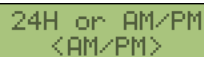

24H or AM/PM
<AM/PM>

Press **Scroll Up** or **Scroll Down** to select your choice.

Pool Capacity

There are two options for determining the **Pool Capacity**. If you know the pool capacity in gallons, the **Manual** screen below allows you enter the number of gallons. If the capacity is unknown, you can select **Calculate**. The capacity is calculated automatically based on the **Pool Shape**, **Average Pool Length**, **Width**, and **Depth**. Refer to **Calculate** on **page 18**.



Pool Capacity
123456 Gallons

Pool Capacity (Manual)

If you know the pool capacity in gallons, select **Manual** and enter the number of gallons. The valid range is 350 – 250,000 gallons.



Pool Capacity
<Manual>



Pool Capacity
<-----> Gallons

Press **Scroll Down** to select **Manual**. Press **MENU/ENTER** again to confirm your choice.

Note: Each press of the **Scroll Up** or **Scroll Down** button increases or decreases the pool capacity in increments of ten (10). Press and hold the **Scroll Up** or **Scroll Down** button for two (2) seconds to increase or decrease the pool capacity in increments of one hundred (100).

Refer to **Pump Capacity** on **page 20** for the next option in the **Manual** sequence.

Pool Capacity (Calculate)

If the pool capacity is unknown, select **Calculate**. The capacity is calculated automatically based on the **Pool Shape**, **Average Pool Length**, **Width**, and **Depth**.

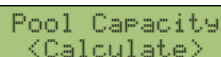

Pool Capacity
<Calculate>

Neptune® 1.5, 1.65, 2.25, 2.7, & 3.45 THP Pool Pump Motor

Press **Scroll Up** or **Scroll Down** to select **Calculate**. Press **MENU/ENTER** to accept the selection. **Input Mode** is automatically activated on entry.

Pool Shape (Calculate)

There are three options for **Pool Shape**: **Rectangle**, **Oval**, or **Round**.

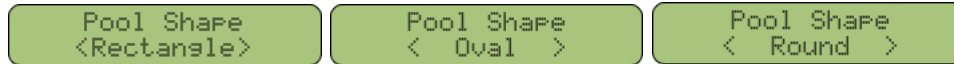

Press **Scroll Up** or **Scroll Down** to select the **Pool Shape**. Press **MENU/ENTER** to save the changes. Press **Scroll Down** to advance to the next menu screen.

Note: If you select **Round** as the **Pool Shape**, you are prompted to enter the **Pool Diameter** before advancing to the next input screen.

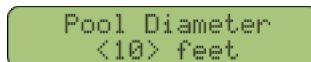

Input Mode is automatically activated on entry. The valid range is 6 – 40 feet. Press **Scroll Up** or **Scroll Down** to increase or decrease the **Pool Diameter**. After saving the changes, the next menu screen in this case is **Average Pool Depth**. See below.

Average Pool Length (Calculate)

Input Mode is automatically activated on entry. The valid range is 5 – 45 feet.

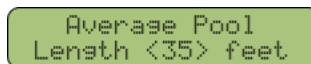

Press **Scroll Up** or **Scroll Down** to increase or decrease the **Average Pool Length**.

Average Pool Width (Calculate)

Input Mode is automatically activated on entry. The valid range is 5 – 30 feet.

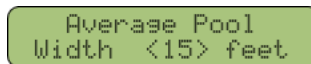

Press **Scroll Up** or **Scroll Down** to increase or decrease the **Average Pool Width**.

Average Pool Depth (Calculate)

Input Mode is automatically activated on entry. The valid range is 2 – 10 feet.



Press **Scroll Up** or to **Scroll Down** increase or decrease the **Average Pool Depth**.

Calculated Pool Capacity

The motor calculates the pool capacity based on the **Pool Shape**, **Average Pool Length**, **Width**, and **Depth**. This is an information screen only.

Note: **Scroll up** is disabled on this screen.



Press **MENU/ENTER** or **Scroll Down** to cycle to the next menu screen.

Neptune® 1.5, 1.65, 2.25, 2.7, & 3.45 THP Pool Pump Motor

Pump Capacity

There are two options for **Pump Capacity**. If you know the **Pump Capacity**, select **Manual** and enter the number of gallons per minute (GPM). If the capacity is unknown, select **Calculate**, and have the pool pump motor calculate the estimated capacity based on Total Horsepower (THP).

Pump Capacity
70 GPM

Note: The GPM for **Pump Capacity** is at 100% speed.

Pump Capacity (Manual)

Press **Scroll Down** to select **Manual**. Press **MENU/ENTER** to confirm your choice. **Input Mode** is automatically activated on entry to the screen.

Refer to the table below. The number of GPM is keyed to the THP listed on the motor nameplate.

Pump Capacity
<Manual>

Pump Capacity
<___> GPM

THP	≈ GPM
0.95	42
1.25	59
1.65	70
2.25	81
2.70	96
3.45	137

Note: Each press of the **Scroll Up** or **Scroll Down** button increases or decreases the GPM. Press and hold the **Scroll Up** or **Scroll Down** button for two (2) seconds to increase or decrease the pool capacity in increments of ten (10).

After saving the changes, the next screen in this case is **Edit DOE Speeds**. See below.

Pump Capacity (Estimate)

Press **Scroll Down** to select **Estimate**. Press **MENU/ENTER** to confirm your choice. **Input Mode** is automatically activated on entry to the screen. Refer to the chart above to identify the **Motor Horsepower**.

Pump Capacity
<Estimate>

Motor Horsepower
<3.45> HP

If the THP of your pool pump motor is not listed in the chart, use the nearest THP equivalent.

Neptune® 1.5, 1.65, 2.25, 2.7, & 3.45 THP Pool Pump Motor

Edit DOE Speeds

The running time of the pool pump motor is divided into four (4) operating speeds grouped into lower and higher ranges. No more than half of the motor running time in a given day is at higher speeds. If you adjust a DOE Speed and save the setting, the next time the cycle runs it will run at the speed you selected.

Speed Group	DOE Speed Setting	Speed Range Percentage	Default % of Max Speed (Nominal RPM)	Maximum Speed in Range
Lower	Speed 1	18-40%	30% (1035)	1380 (40%)
	Speed 2	45-55%	50% (1725)	1897 (55%)
Higher	Speed 3	75-85%	80% (2760)	2932 (85%)
	Speed 4	100% (only)	100% (3450)	3450 (100%)

You can adjust the default setting for **Speeds 1-3** within the allowable range assigned to each.

Edit DOE
Speeds <Yes>

Scroll Up or **Scroll Down** to select **Yes** and confirm your choice.

DOE Speed 1

The valid range is 18-40%.

DOE Speed 1
< 30>%

Press **Scroll Up** or **Scroll Down** to increase or decrease the percentage.

Note: Press and hold the **Scroll Up** or **Scroll Down** button to increase or decrease the percentage in increments of ten (10).

DOE Speed 2

The valid range is 45-55%.

DOE Speed 2
< 50>%

Press **Scroll Up** or **Scroll Down** to increase or decrease the percentage.

DOE Speed 3

The valid range is 75-85%.

DOE Speed 3
< 80>%

Press **Scroll Up** or **Scroll Down** to increase or decrease the percentage.

DOE Speed 4

The valid range is 100% only. You cannot edit the percentage in this screen.

DOE Speed 4
<100>%

Press **Scroll Down** to cycle to the next screen.

Remote Control

The **RS-485 Port** allows you to connect an external controller to the Drive Interface Board on the pool pump motor. When connected and configured, the UI no longer controls the motor. Commands from the external controller take priority. Other than enabling or disabling **Remote Control** and possibly the **Node ID**, the UI no longer plays a role in motor communication. For information on connecting an external controller, refer to the **RS-485 Port** on [page 38](#).



Remote Control
<Disable>

Contact US Motors / Nidec Motor Corporation for the proper communication protocol. If an external controller is used, make sure the line is an isolated, non-grounded connection.

Press **Scroll Up** or **Scroll Down** to toggle the setting between **Disable** and **Enable**. After saving the changes, the menu cycles to the next screen, which in this case is **Node ID**. See below.

Press **START/PAUSE** three (3) times to exit the menu option and menu tree. After exiting the menu tree, the control enters **Remote Mode** automatically. In this case, it does not return to normal operation.

Node ID

Node ID sets the MODBUS RTU address that is used to communicate with the pool pump motor in **Remote Mode**. The **Node ID** can be set to any number between 1 and 247. The default number is 240. This option is not available unless **the Remote Control** setting above is **Enabled**.



Node ID
<240>

Note: Each press of the **Scroll Up** or **Scroll Down** button increases or decreases the **Node ID** number. Press and hold the **Scroll Up** or **Scroll Down** button for two (2) seconds to increase or decrease the number in increments of ten (10). Press and hold the **Scroll Up** or **Scroll Down** button continuously to increase or decrease the number in increments of one hundred (100).

Disable Remote Control

If **Remote Mode** is enabled, follow these steps to return control of the pump to the UI.

1. Press and hold the **Speed 2** and **Speed 3** buttons simultaneously for five (5) seconds. If a button press is not detected in ten (10) seconds, the UI reverts to **Remote Mode**.

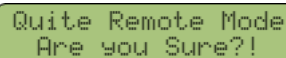

Quite Remote Mode
Are you Sure?!

2. Press **MENU/ENTER** to save the changes and return to **Navigation Mode**.

After confirming the change, the pump stops, if it is running, and initially moves to **Standby Mode**. The pump will no longer respond to commands from the external control system. If a programmed flow is scheduled to run at this time, it will restart the motor at the programmed flow speed. Otherwise, it will remain in **Standby Mode**. Other options, for example timed flow programming, can be accessed.

My Pool Settings

Options under the **My Pool Settings** allow you to set temperature readings to Celsius or Fahrenheit, priming duration and speed, low temperature monitoring and threshold, remote system monitoring, or reset configurations to default values. You can also disable DOE Scheduling from this menu tree.

Neptune® 1.5, 1.65, 2.25, 2.7, & 3.45 THP Pool Pump Motor

Temperature Unit

You can configure the pump to display temperature readings in **Fahrenheit** or **Celsius**.

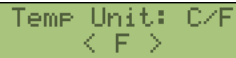

Temp Unit: C/F
< F >

Press **Scroll Up** or **Scroll Down** to toggle the setting between **F** or **C**.

Priming Duration

Pump priming functionality sets the duration time for the priming stage. The default time is three (3) minutes. **Priming Duration** range is from 0-9 minutes. A setting of zero (0) disables priming.

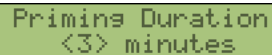

Priming Duration
<3> minutes

Press **Scroll Up** or **Scroll Down** to increase or decrease the number of minutes.

Priming Speed

Anytime the motor is started after it has been off and is not running, the control primes the pump first by running at a designated speed for the duration indicated in the **Priming Duration** setting. By default, the priming speed is 2850 RPM. You can adjust the **Priming Speed** RPM.



Priming Speed
<2850> RPM

Scroll Up or **Scroll Down** button increases or decreases the **RPM**.

Note: Each press of the **Scroll Up** or **Scroll Down** button increases or decreases the **RPM** in increments of ten (10). Press and hold the **Scroll Up** or **Scroll Down** button for two (2) seconds to increase or decrease the **RPM** in increments of one hundred (100).

Low Temperature Monitor

The control monitors the ambient temperature of the pump. If the temperature falls below a specified threshold, the pump begins cycling on and off in an attempt to prevent the water from freezing in the pump.

If the motor is not currently running, it switches on for 30 minutes at 1200 RPM. The motor then idles for 30 minutes. At the end of 30 minutes if the temperature is still below the low temperature threshold, the cycle repeats itself. By default, this feature is enabled.

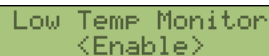

Low Temp Monitor
<Enable>

Press **Scroll Up** or **Scroll Down** to toggle the setting to **Enable**.

Low Temperature Threshold

The **Low Temperature Threshold** is configurable within a range of 32° F to 50° F (0° C to 10° C).

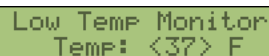

Low Temp Monitor
Temp: <37> F

Press **Scroll Up** or **Scroll Down** to increase or decrease the digit.

Neptune® 1.5, 1.65, 2.25, 2.7, & 3.45 THP Pool Pump Motor

View Version Numbers

Screens under this option are used for diagnostic purposes. They are informational only. By default, the screens are hidden.



View Version
Numbers <Yes>

Press **Scroll Up** and toggle the option to **Yes**.

MC Version

This screen displays information about the **Motor Control Version**.



MC Version
A127 E1234

Press **Scroll Down** to move to the next information screen.

DI Version

This screen displays information about the **Drive Interface Version**.

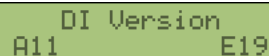

DI Version
A11 E19

Press **Scroll Down** to cycle to the next screen.

UI Version

This screen displays information about the **User Interface Version**.



UI Version
A13 E24

Press **Scroll Down** to cycle to the next screen.

Reset To Factory Defaults

This option allows you to reset all parameters in all menus back to the factory default settings. Refer to **page 49** for a list of the default values.

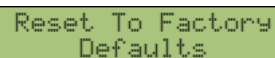

Reset To Factory
Defaults

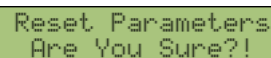

Reset Parameters
Are You Sure?!

When **Are You Sure?!** flashes on the second line, press **MENU/ENTER** to confirm the choice.

Pump Off Time Duration

The pool pump motor is configured to move a specified number of GPM based on pool capacity (volume) and pump capacity (THP of the motor) in each daily cycle. This setting specifies the length of time the motor is to be off during its daily cycle if it is possible. The motor attempts to meet as much of the requested off time as possible while still meeting its pumping goal.

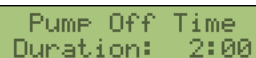

Pump Off Time
Duration: 2:00

Press **Scroll Up** or **Scroll Down** to increase or decrease the **Hours**. Press **MENU/ENTER** to cycle the edit field to the right and adjust the **Minutes**. Press **Scroll Up** or **Scroll Down** to increase or decrease the **Minutes** in increments of fifteen (15).

Note: The next screen in the sequence, **Pump Off Time Start**, is not shown, i.e., disabled if **Pump Off Time Duration** is zero.

Neptune® 1.5, 1.65, 2.25, 2.7, & 3.45 THP Pool Pump Motor

Pump Off Time Start

This setting specifies the start time that the motor is to be off.

```
Pump Off Time  
Start: 9:00 AM
```

Press **Scroll Up** or **Scroll Down** to increase or decrease the **Hours**. Press **MENU/ENTER** to cycle the edit field to the right and adjust the **Minutes**. Press **MENU/ENTER** to cycle the edit field to the right and adjust the **AM/PM** setting.

Low Cost Time

Different regions of the country may have different energy rates at different times of the day. This setting allows you to align the time period of highest energy usage so that it falls into the **Low Cost Time** that you specify to help minimize the cost of energy.

```
Low Cost Time  
Start: 1:00 AM
```

Press **Scroll Up** or **Scroll Down** to increase or decrease the **Hours**. Press **MENU/ENTER** to cycle the edit field to the right and adjust the **Minutes**. Press **MENU/ENTER** to cycle the edit field to the right and adjust the **AM/PM** setting.

Flow Adjustment

This setting allows you to balance the amount of water cycled in a day and pool pump motor usage. The default value is 5. If you want more water cycled, adjust the number up. If you want to reduce motor usage a little, adjust the number down.

```
Flow Adjustment  
1=Low <5> 9=High
```

Press **Scroll Up** or **Scroll Down** to increase or decrease the digit.

Disable DOE Scheduling

If you want to use the manual **Timer Settings** and related configuration options, the **DOE Scheduling** must be disabled first. Different menu tree structures are available after that.

```
Disable DOE  
Scheduling <Yes>
```

Press **Scroll Down** to toggle the option to **Yes**.

```
Disabling DOE  
Are You Sure?!
```

The **Disabling DOE Are You Sure?!** screen appears. Press **MENU/ENTER** to confirm the choice and save the changes. **Note:** You must press **START/PAUSE** to exit the menu option and return to **Navigation Mode** with **DOE Scheduling** disabled.

Manual Time Mode is now enabled along with associated menu trees and configuration options. Refer to the **Timers Menu** on **page 32** for information on programming **Timers**.

DOE Features Disabled

When DOE Scheduling features are disabled, manual timers and related settings are enabled.

There are three (3) top-level menus in **Manual Timer Mode: Install Settings, My Pool Settings, and Timer Settings**. Options under the menus allow you to customize the settings and adjust program timers related to these settings.

Menu Trees

Install Settings

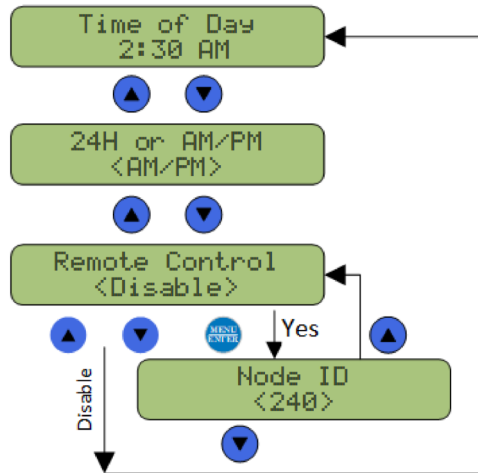

My Pool Settings

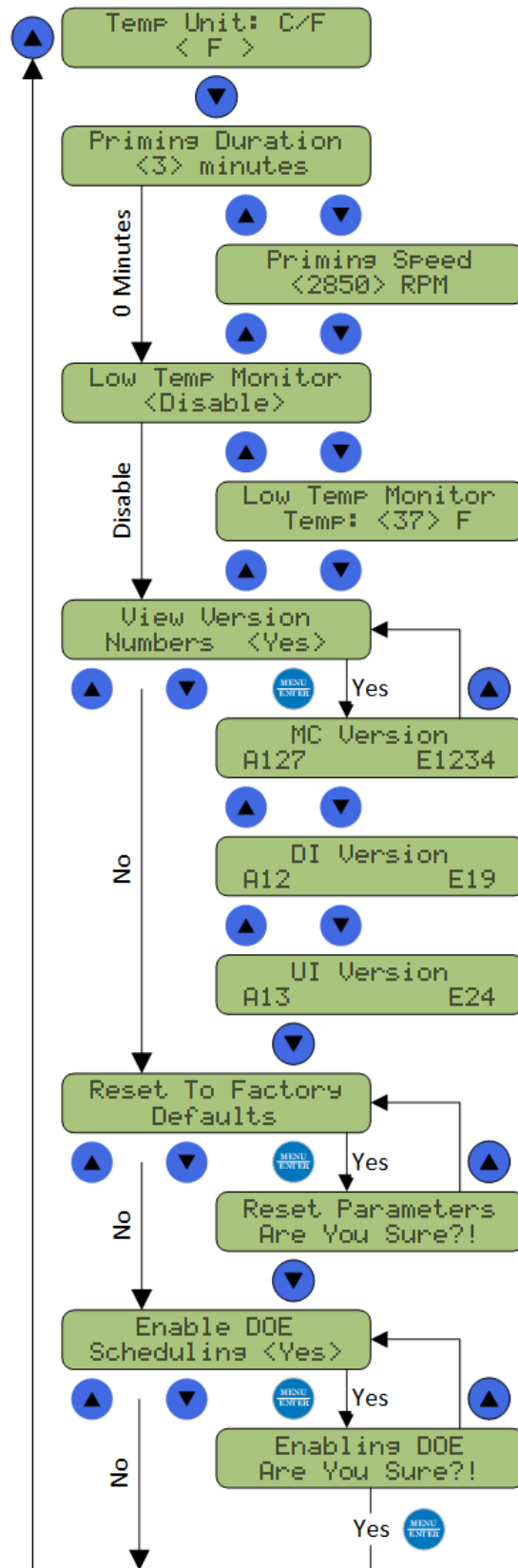

Timer Settings

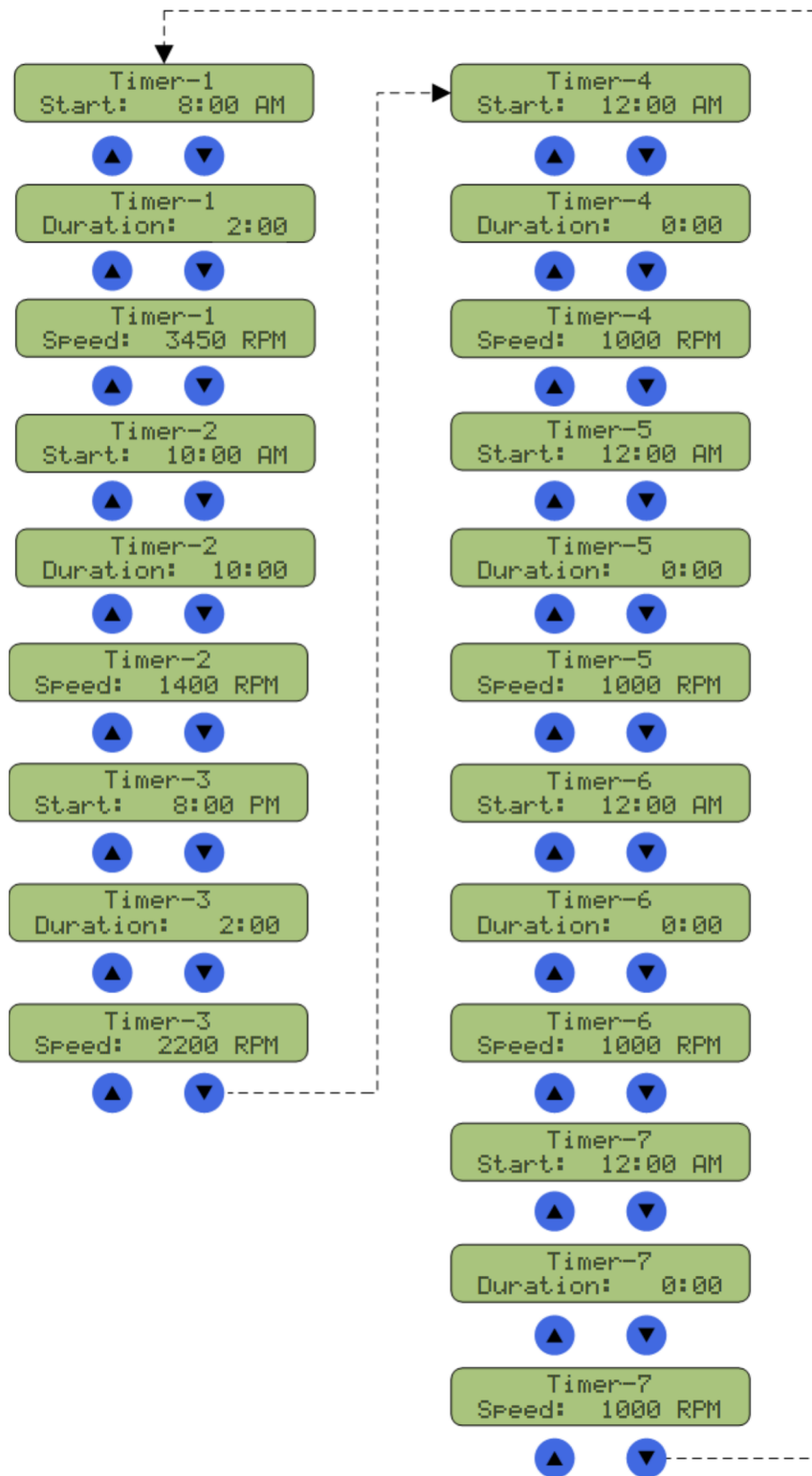

Neptune® 1.5, 1.65, 2.25, 2.7, & 3.45 THP Pool Pump Motor

Install Settings

Begin the manual programming of the pool pump motor from this menu. The control compares the time of day entered against programmed schedule times to determine the next pump operation.

Note: The navigation features described below are specific to each screen option. For general navigation, refer to the **Interface Buttons** on **page 14**. After adjusting a value, you must press **MENU/ENTER** to save the changes.

Time of Day

Timers 1-7 in the **Timers Menu** (if all are activated) are keyed to this setting.

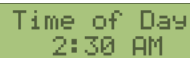

Time of Day
2:30 AM

Press **Scroll Up** or **Scroll Down** to adjust the field blinking in the LCD display. Press **MENU/ENTER** to cycle the edit field to the right. Press **Scroll Up** or **Scroll Down** to increase or decrease the **Hours**, **Minutes**, and adjust the **AM/PM** field.

24H or AM/PM

You can configure the pump to display time in a **24-Hour** clock or 12-Hour **AM/PM** format.

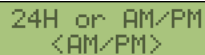

24H or AM/PM
<AM/PM>

Press **Scroll Up** or **Scroll Down** to toggle the selection between **24H** or **AM/PM**.

Remote Control

The **RS-485 Port** allows you to connect an external controller to the Drive Interface Board on the motor. When connected and configured, the UI no longer controls the motor. Commands from the external controller take priority. Other than enabling or disabling **Remote Control** and possibly the **Node ID**, the UI no longer plays a role in motor communication. For information on connecting an external controller, refer to the **RS-485 Port** on **page 38**.

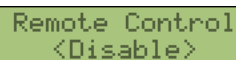

Remote Control
<Disable>

Contact US Motors / Nidec Motor Corporation for the proper communication protocol. If an external controller is used, make sure the line is an isolated, non-grounded connection.

Press **Scroll Up** or **Scroll Down** to toggle the setting between **Disable** and **Enable**. After saving the changes, the menu cycles to the next screen, which in this case is **Node ID**. See below.

Press **START/PAUSE** three (3) times to exit the menu option and menu tree. After exiting the menu tree, the control enters **Remote Mode** automatically. In this case, it does not return to normal operation.

Node ID

Node ID sets the MODBUS address that is used to communicate with the motor in **Remote Mode**. The **Node ID** can be set to any number between 1 and 247. The default is 240. This option is not available unless the **Remote Control** setting above is **Enabled**.

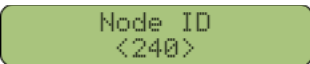

Node ID
<240>

Note: Note: Each press of the **Scroll Up** or **Scroll Down** button increases or decreases the **Node ID** number. Press and hold the **Scroll Up** or **Scroll Down** button for two (2) seconds to increase or

Neptune® 1.5, 1.65, 2.25, 2.7, & 3.45 THP Pool Pump Motor

decrease the number in increments of ten (10). Press and hold the **Scroll Up** or **Scroll Down** button continuously to increase or decrease the number in increments of one hundred (100).

Disable Remote Control

If **Remote Mode** is enabled, follow these steps to return control of the pump to the UI.

1. Press and hold the **Speed 2** and **Speed 3** buttons simultaneously for five (5) seconds. If a button press is not detected in ten (10) seconds, the UI reverts to **Remote Mode**.



Quite Remote Mode
Are you Sure?!

2. Press **MENU/ENTER** to save the changes and return to **Navigation Mode**.

After confirming the change, the pump stops, if it is running, and initially moves to **Standby Mode**. The pump will no longer respond to commands from the external control system. If a programmed flow is scheduled to run at this time, it will restart the pool pump motor at the programmed flow speed. Otherwise, it will remain in **Standby Mode**. Other options, for example timed flow programming, can be accessed.

My Pool Settings

Options under **My Pool Settings** allow you to set temperature readings to **Fahrenheit** or **Celsius**, priming duration and speed, low temperature monitoring and threshold, remote system monitoring, or reset configurations to default values. **Note:** By default, some menu options are not available unless the associated menu option is enabled.

Temperature Unit

You can configure the pump to display temperature readings in **Fahrenheit** or **Celsius**.

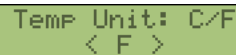

Temp Unit: C/F
< F >

Press **Scroll Up** or **Scroll Down** to toggle the setting between **F** or **C**.

Priming Duration

Pump priming functionality sets the duration time for the priming stage. The default time is three (3) minutes. **Priming Duration** range is from 0-9 minutes. A setting of zero (0) disables priming.

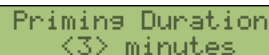

Priming Duration
<3> minutes

Press **Scroll Up** or **Scroll Down** to increase or decrease the number of minutes.

Priming Speed

Anytime the motor is started after it has been off and is not running, the control primes the pump first by running at a designated speed for the duration indicated in the **Priming Duration** setting. By default, the priming speed is 2850 RPM. You can adjust the **Priming Speed** RPM.



Priming Speed
<2850> RPM

Scroll Up or **Scroll Down** button increases or decreases the **RPM**.

Note: Each press of the **Scroll Up** or **Scroll Down** button increases or decreases the **RPM** in increments of ten (10). Press and hold the **Scroll Up** or **Scroll Down** button for two (2) seconds to increase or decrease the **RPM** in increments of one hundred (100).

Neptune® 1.5, 1.65, 2.25, 2.7, & 3.45 THP Pool Pump Motor

Low Temperature Monitor

The control monitors the ambient temperature of the pump. If the temperature falls below a specified threshold, the pump begins cycling on and off in an attempt to help keep water from freezing in the pump.

If the pump is not currently running, it switches on for thirty (30) minutes at 1200 RPM. The pump then idles for 30 minutes. If at the end of thirty (30) minutes the temperature is still below the low temperature threshold, the cycle repeats itself. By default, this feature is **Enabled**.

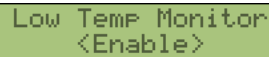

Low Temp Monitor
<Enable>

Press **Scroll Up** or **Scroll Down** to toggle the setting.

Low Temperature Threshold

The threshold is configurable between a range of 32° F to 50° F (0° C to 10° C).

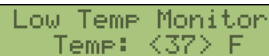

Low Temp Monitor
Temp: <37> F

Press **Scroll Up** or **Scroll Down** to increase or decrease the digit.

View Version Numbers

Screens under this option are used for diagnostic purposes. They are informational only.



View Version
Numbers <Yes>

Press **Scroll Up** or **Scroll Down** to toggle the option to **Yes**.

MC Version

This screen displays information about the **Motor Control Version**.



MC Version
A127 E1234

Press **Scroll Down** to move to the next information screen.

DI Version

This screen displays information about the **Drive Interface Version**.

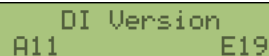

DI Version
A11 E19

Press **Scroll Down** to cycle to the next menu screen.

UI Version

This screen displays information about the **User Interface Version**.

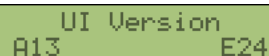

UI Version
A13 E24

Press **Scroll Down** to cycle to the next menu screen.

Neptune® 1.5, 1.65, 2.25, 2.7, & 3.45 THP Pool Pump Motor

Reset To Factory Defaults

This setting allows you to reset all parameters in all menus back to the factory default settings. Refer to **page 49** for a list of the default parameters.

Reset To Factory
Defaults

Reset Parameters
Are You Sure?!

When the **Reset Parameters** screen appears with **Are You Sure?!** flashing on the second line, press **MENU/ENTER** to confirm the choice and save the changes.

Enable DOE Scheduling

Use this setting to re-enable **DOE Scheduling** and related options. The DOE menu trees are available after that.

Enable DOE
Scheduling <Yes>

Enabling DOE
Are You Sure?!

Press **Scroll Down** to toggle the option to **Yes**. The **Enabling DOE Are You Sure?!** screen appears. Press **MENU/ENTER** to confirm the choice and save the changes.

Note: You must press **START/PAUSE** to exit the menu option and return to **Navigation Mode** with **DOE Scheduling** enabled.

Timer Settings

Timers 1-7

The pool pump motor offers you the flexibility of customizing up to seven Timers. The Timers control when the pump switches on and off throughout the day. You can customize the **Start Time**, **Duration**, and **Speed** for each. Control logic begins at the speed with the *earliest* start time of the day and continues running that speed until the next start time of day is reached. If the Timer schedule is configured in such a way that run times overlap, the Timers run in priority from **Timer-1** (highest) through **Timer-7** (lowest). The default schedule is as follows:

Timer #	Start Time	Duration	Speed
Timer-1	8:00 AM	2 Hours	3450 RPM
Timer-2	10:00 AM	10 Hours	1400 RPM
Timer-3	8:00 PM	2 Hours	2200 RPM
Timer-4*	12:00 AM	0 Hours	1000 RPM
Timer-5*	12:00 AM	0 Hours	1000 RPM
Timer-6*	12:00 AM	0 Hours	1000 RPM
Timer-7*	12:00 AM	0 Hours	1000 RPM

*By default, **Timers 4 – 7** are disabled. A **Duration of 0** deactivates a Timer.

To program any of the **Timers**, follow the steps listed below. This example uses **Timer-1**. The process is the same for each of them.

Timer-1
Start: 8:00 AM

Neptune® 1.5, 1.65, 2.25, 2.7, & 3.45 THP Pool Pump Motor

Press **Scroll Up** or **Scroll Down** to increase or decrease the **Hour**. Press **MENU/ENTER** to cycle the edit field to the right. Press **Scroll Up** or **Scroll Down** to increase or decrease the **Minutes**. Press **MENU/ENTER** to cycle the edit field to the right. Press **Scroll Up** or **Scroll Down** to select **AM/PM**.

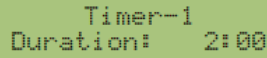

Timer-1
Duration: 2:00

Press **Scroll Up** or **Scroll Down** to increase or decrease the **Hour**. Press **MENU/ENTER** to cycle the edit field to the right. Press **Scroll Up** or **Scroll Down** to increase or decrease the **Minutes** in increments of fifteen (15).



Timer-1
Speed: 3450 RPM

Each press of **Scroll Up** or **Scroll Down** increases or decreases the **RPM** in increments of ten (10). Press and hold **Scroll Up** or **Scroll Down** continuously to increase or decrease the **RPM** in increments of one hundred (100).

Press **Scroll Down** to cycle to the next menu screen, which in this case would be **Timer-2 Start**.

Override a Timer

You can override the speed and flow rate programmed into **Timers 1 – 7** (if all timers are activated) without having to re-program the pump. Simply press one of the **Speed** buttons on the UI. Here is the pre-programmed speed and flow rate for each.

Button	Description
Speed 1	Force an override speed of 1350 RPM.
Speed 2	Force an override speed of 1725 RPM.
Speed 3	Force an override speed of 2760 RPM.

You can also adjust the RPM within the override. Press the **Scroll Up** or **Scroll Down** button to increase or decrease the RPM in increments of ten (10). Press and hold either button for two (2) seconds to increase or decrease the RPM in increments of one hundred (100).

The effect of the button press depends on whether the pump is currently running a Timer or standing by to execute the next Timer on the schedule.

With the Pump in Run Mode

When the pump is running a Timer, pressing the **Speed 1**, **Speed 2**, or **Speed 3** button forces an override of the Timer currently under way. The motor begins running at the pre-programmed RPM assigned to the button for the remaining duration of the flow.

Note: Pressing the **START/PAUSE** button will pause the motor.

With the Pump in Pause Mode

Under normal operating conditions, you must press **START/PAUSE** again to un-pause the motor.

With the Pump in Standby Mode

When the motor is in **Standby Mode**, pressing **Speed 1**, **Speed 2**, or **Speed 3** enables a Quick Start. In this case, the motor runs at the RPM assigned to the speed button until either the time the next scheduled flow is due to start, or the **START/PAUSE** button is pressed.

Note: Pressing the **START/PAUSE** button pauses the motor.

Keypad Lockout

Lock the Menus

You can lock the menus to prevent unintended modifications to the settings and schedules. With the motor in **Standby Mode**, press the **MENU/ENTER** button and hold the button down for three (3) seconds. The LCD screen flashes and displays the following message for ten (10) seconds.

Note: If the control does not detect a button press within that time frame, the request to lock the keypad is cancelled.

Press Enter Key
To Lock Menus

Press the **MENU/ENTER** button within the time frame to confirm the operation. The LCD screen then displays the following message for two (2) seconds and returns to normal operation. When the menus are locked, the UI displays the following message and flashes anytime the **MENU/ENTER** button is pressed.

Menus Locked

Unlock the Menus

With the pool pump motor in **Standby Mode**, press the **MENU/ENTER** button and hold the button down for three (3) seconds. The LCD screen flashes and displays the following message for ten (10) seconds. **Note:** If the control does not detect a button press within the time frame, the request to unlock the keypad is cancelled.

Press Enter Key
To Unlock Menus

Press the **MENU/ENTER** button again to confirm the operation. The LCD screen displays the following message for two (2) seconds and then returns to normal operation.

Menus Unlocked

Operational States

The table below describes the operational states of the pool pump motor.

State	Description
Fault	The pool pump motor moves into this state in response to the detection of a fault condition in either the motor or the control.
Navigation	Pressing the MENU/ENTER button while in Standby shifts the motor to the Navigation state in which the motor can be configured.
Pause	The control is waiting for START/PAUSE to un-pause. Scheduled events will not run in Pause state.
Power Loss	If the control detects low voltage, it prepares the motor for a possible power loss.
Power On	Initialize the motor and all communication ports. The motor is ready to run.
Remote	The pump is operating under commands it receives from a central controller. The UI is bypassed in this operational state.
Run	The pump is running in response to a timer, a manual override, a manual pool cleaning, or a low temperature event.
Standby	The pump is not paused and there is no timed flow scheduled at the moment.

Enable Manual Timers

The motor ships with the DOE features **enabled**. The DOE Scheduling must be **disabled** before you can configure and program Manual Timers and related settings. Refer to **Disabling DOE** on **page 25**.

Clean and Override Operations

The clean operation always runs at 3450 RPM for 30 minutes. Pressing a **Speed** button cancels the clean and the associated timer. The motor then shifts to the speed associated with the **Speed** button. In **Run Mode** or **Standby Mode**, the **Speed** and the **Clean** buttons execute as follows:

Button	Description
Speed 1 ^a	Force an override speed of 1350 RPM.
Speed 2 ^a	Force an override speed of 1725 RPM.
Speed 3 ^a	Force an override speed of 2760 RPM.
Clean ^b	Start a 30-minute cleaning cycle at a speed of 3450 RPM (100% flow).

^aYou can adjust the RPM in a pre-configured override. Press the **Scroll Up** or **Scroll Down** button to increase or decrease the RPM in increments of ten (10). Press and hold either button for two (2) seconds to increase or decrease the RPM in increments of one hundred (100).

^bIf **Speed x** is pressed while cleaning, the **Clean** operation and the **Clean Timer** are canceled. If **Clean** is pressed again while cleaning, the **Clean Timer** will be reset to 30 minutes to extend the cleaning time.

Example: After pressing a **Speed** button, the motor continues to run until the next timed flow is set to run, which potentially could be several hours. If you press **Clean**, the motor runs for 30 minutes and shuts off. However, if you press **Clean**, run the cycle for a short time (e.g., 5 minutes), and then press a **Speed** button, the clean cycle is canceled and the motor changes to the speed associated with the **Speed** button. Depending on the start time of the next timed flow, the motor may run for more than or less than 30 minutes.

Note: Priming during a cleaning cycle is bypassed when the **Cleaning Speed** is greater than or equal to the default **Priming Speed** of the pool pump motor. Refer to the **Priming Duration** and **Priming Speed** settings on **page 30**.

In **Run Mode** or **Standby Mode**, pressing **START/PAUSE** pauses the motor and cancels the override. Press **START/PAUSE** again to run the motor at the scheduled speed, which could be **Off**.

Pump Control via the DI Board

The Drive Interface (DI) Board is powered by an isolated low voltage (+12 Vdc) power supply. The DI Board supports the following customer inputs, in addition to the User Interface:

- Four (4) Discrete Switch Inputs
- MODBUS RS-485 Port

Discrete Switch Inputs

The DI Board uses a pre-set hierarchy for establishing which input has priority.

- Switch Inputs (with INP #4 having the highest priority)
- 9-30 Vac/dc
- User Interface (lowest priority)

Switch closures on the discrete inputs operate the pool pump motor at pre-defined speeds shown in the table below. Switches may be sourced from the +12V terminal, or an external DC supply can be used. When using an external supply, make sure to complete the circuit by connecting the GND terminal to the external supply's ground.

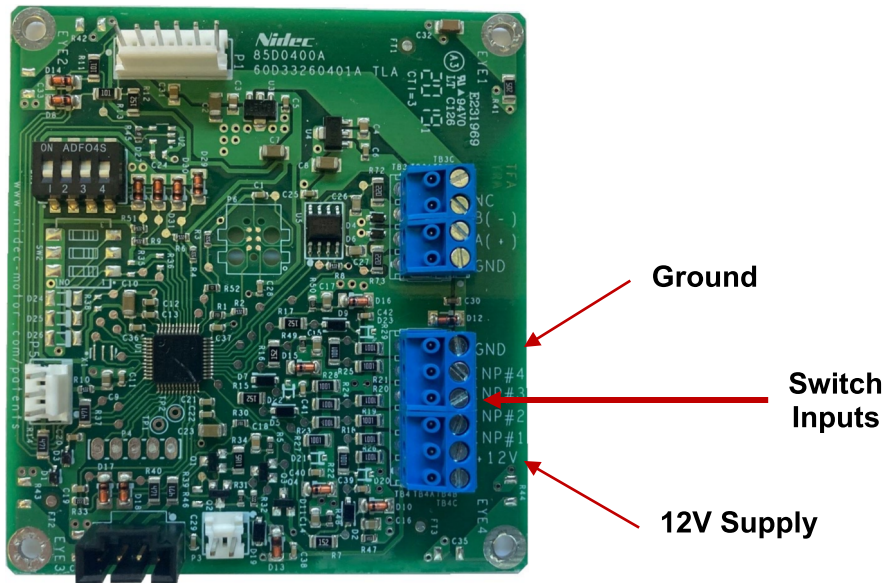

Input Priority

Input Priority	RPM
INP #4	3450
INP #3	2933
INP #2	1898
INP #1	1380

Neptune® 1.5, 1.65, 2.25, 2.7, & 3.45 THP Pool Pump Motor

Terminals and Function



Terminal	Function
TB4-6	+12V
TB4-5	INP #1
TB4-4	INP #2
TB4-3	INP #3
TB4-2	INP #4
TB4-1	GND

Control Panel Connections

Low voltage can be supplied from the **Control Panel** side. This should be a continuous source of voltage. It is usually supplied from the pool automation system. In some cases, a dedicated supply may be needed for a specific installation.

⚠ WARNING

- Always disconnect electrical power at the fuse box or circuit breaker panel before handling electrical connections or performing maintenance on this unit. Allow the pool pump motor to come to a complete stop and wait three (3) minutes. This allows the capacitors to discharge any residual voltage for safety.
- Verify all voltages prior to making any connections.
- Avoid contact with energized circuits and rotating parts.

⚠ CAUTION

- Wear safety glasses to inspect the equipment while it is running or while working on equipment.

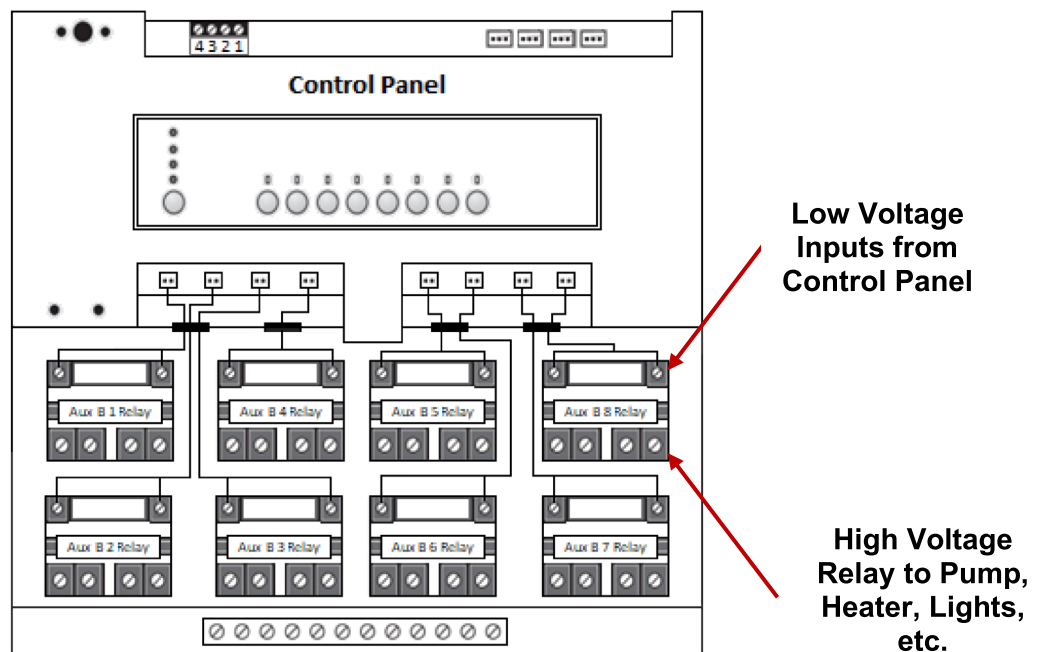

Neptune® 1.5, 1.65, 2.25, 2.7, & 3.45 THP Pool Pump Motor

Power: Within the Low Voltage area of the pool automation system, identify a source of 9-24 Vac or Vdc for interface power and connect to +DC/AC and -DC/AC terminals. This should be a continuous source of voltage. This can usually be supplied from the pool automation system, but a dedicated supply may be needed in some installations.

Inputs: Connect to the desired relay coil voltages (**Not the Relay Outputs!**) to control speed as desired. Inputs are low voltage, 9-24 Vac or Vdc.

DI Board Connections

Connections can be made from the Low Voltage side of the relay to the Discrete Inputs on the DI Board. The example below will run **Speed 1**, provided the Aux 2 (relay) is energized. This can be reproduced for other relays.

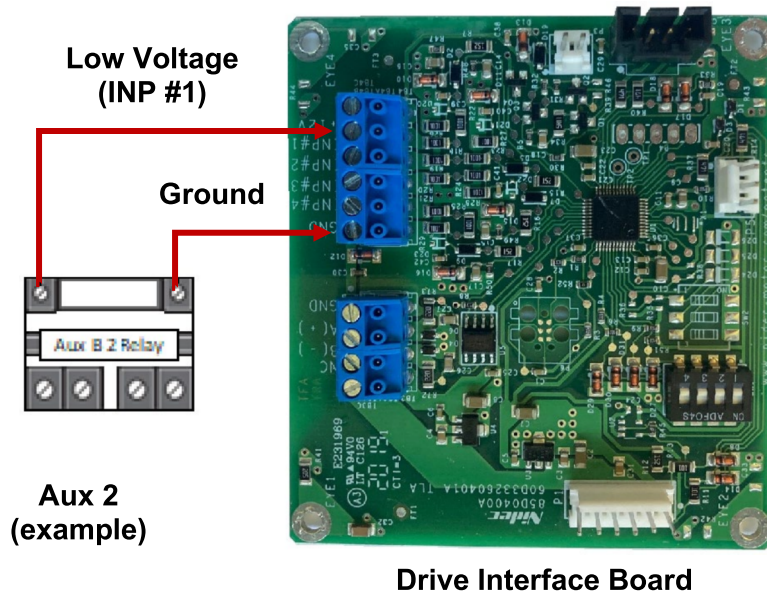

RS-485 Port

RS-485 is an industrial specification that defines the electrical interface and physical layer for point-to-point communication of electrical devices. The RS-485 standard allows for long cabling distances in electrically noisy environments and can support multiple devices on the same bus.

The **RS-485 Port** allows you to connect an external controller. When connected and configured, the UI no longer controls the pool pump motor. Commands from the external controller take priority. Other than enabling or disabling **Remote Control** and possibly the **Node ID**, the UI plays no role in communication. Contact US Motors/Nidec Motor Corporation for the proper communication protocol. If an external controller is used, make sure the line is an isolated, non-grounded connection.

Terminals and Function



Terminal	Function
TB3-1	GND, MODBUS
TB3-2	A (+), MODBUS
TB3-3	B (-), MODBUS
TB3-4	NO CONNECT

Neptune® 1.5, 1.65, 2.25, 2.7, & 3.45 THP Pool Pump Motor

Wire a Remote Connection

Attach any RS-485-compatible cable to the RS-485 connector.

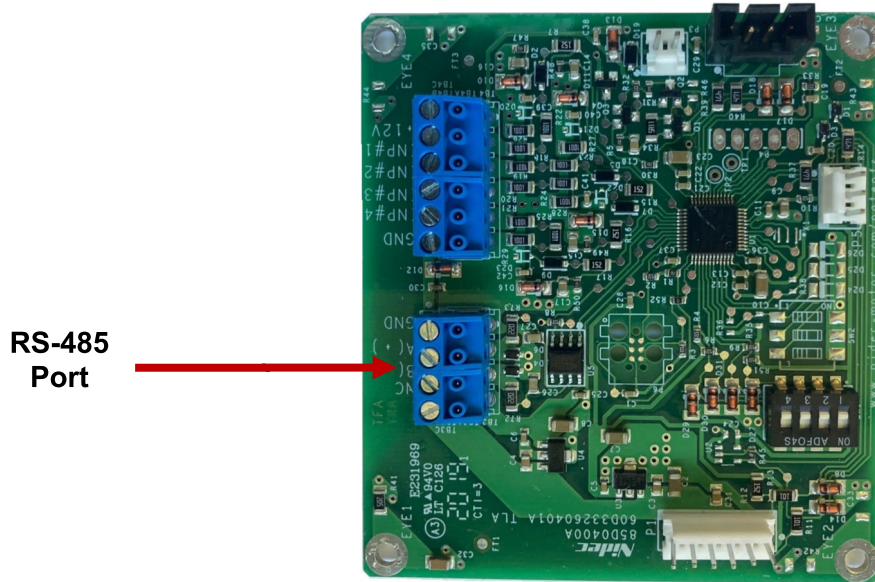

RS-485 Port on the DI Board

Follow these steps to wire a remote connection:

1. Remove the four (4) slotted head hex washer screws securing the UI Cover. Set the cover aside.
2. Remove the conduit plug and feed the RS-485 cable (not supplied) through the compartment. Use a water-tight connector to seal the conduit hole (1/2-14 NPT thread).

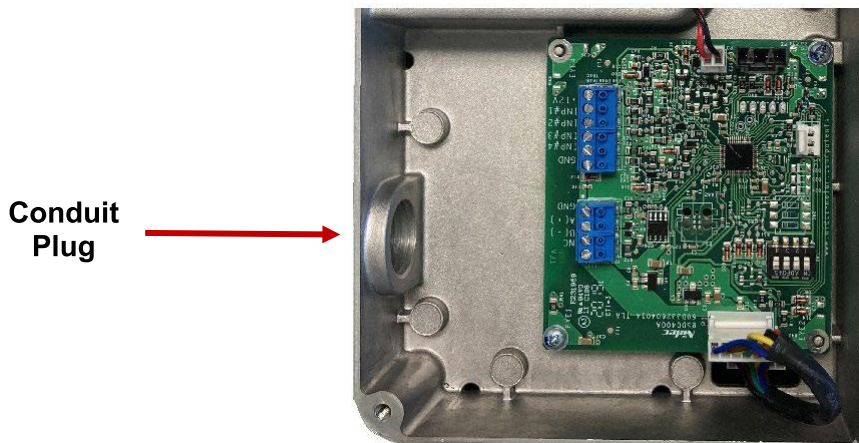

Low Voltage Compartment Conduit Plug

3. Attach the cable leads to the **B (-)**, **A (+)**, and **GND** terminals on the DI Board.
4. Ensure that the cable connecting the UI to the DI Board is routed safely on the side of the **Low Voltage Compartment** only.
5. Set the UI Cover back in place.
6. Secure UI Cover tightly with the four (4) hex screws.

Protections

The unit is designed to protect itself in the event of a fault situation. Fault handling is defined below:

- The control unit disables power to the pool pump motor. (The motor will coast to a stop.)
- If the fault condition clears, the control attempts to restart automatically. For example, if an over-temp fault occurs, the control does not attempt to restart the motor until the temperature drops below the fault threshold.
- The control cycles through the number of retries associated with the given fault condition.

Motor Protection

Control Unit Temperature

Motor output power is reduced until the control unit temperature returns to normal operating parameters. If the motor is unable to reach normal operating temperature by reducing output power, the motor turns off. If the condition clears, the motor automatically restarts.

Low Input Line Voltage

The control turns the motor off for low voltage. When the voltage returns to acceptable operating levels the motor automatically restarts.

Low Temperature Monitor

When the control senses the ambient temperature dropping below the threshold level (as defined by the installer/end-user), the control sends a command for the motor to run at 1200 RPM to help prevent water from freezing in the pool plumbing. Refer to the **Low Temp Monitor** setting on **page 31** for specific information covering the On/Off cycle and adjusting the temperature setting.

Motor Stalled

When the control detects that the motor shaft cannot rotate, the pool pump motor shuts down and automatically restarts when operating conditions are within specifications.

Open Output Phase

When one or more of the three phase lines between the motor and control is not connected well, the output voltage in the control is not able to reach the motor. The motor runs through the Shutdown/Restart sequence several times to correct the fault condition. If that is unsuccessful, the motor stops.

Output Over Current

Motor output power is reduced until the current returns to normal operating parameters. If the motor is unable to reach normal operating current by reducing output power, the motor turns off. If the condition clears, the motor automatically restarts.

Output Over Power

The control monitors shaft output power continuously using estimated speed and torque produced by the motor shaft. The control limits the torque of the motor to maintain shaft output power below or equal to the maximum power limit. If the overload condition reduces the speed beyond the designed operating range, the motor stops.

Hardware Protection

Fuse Protection

The unit includes fuse protection to meet UL® component failure testing. Fuses are not user-serviceable and are intended to last the life of the product.

Inrush Protection

The inverter limits inrush current to less than 150A peak surge. The duration is less than 5ms.

Mechanical Requirements

Connections

Input power and control signals are via conduit connections. There are two compartments: See **Wire the Pool Pump Motor** on page 10.

- High Voltage input power
- Low Voltage control inputs

The High Voltage Compartment is supplied with a threaded hole for 1/2" NPT conduit connection for use with the required, sealed conduit connector and screw terminals appropriate for the voltage and current present. The terminals accommodate #12 – #14 AWG wire-size and 1/4" "Quick-Connect" clips.

Environmental Requirements

Environmental Ranges

The pool pump motor is designed for indoor or outdoor use with temperatures in the following ranges.

Type	Range
Full Shaft Output Power	39° F to 122° F (4° C to 50° C)
Storage Temperature Range	-67° F to 203° F (-55° C to 95° C)
Humidity	0-99.5% RH (condensing)

Environmental/Ingress Protection

IPX5 rating

Troubleshooting

This troubleshooting guide provides field technicians a step-by-step process for accurately diagnosing and troubleshooting certain problems experienced by the pool pump motor.

However, this section does not override or replace instructions suggested by the manufacturer of the pump system. To prevent misdiagnosis and unneeded repairs, operators should try the steps listed in the Basic Troubleshooting section first. If a problem still exists or there is an ongoing issue after following the steps in the **Basic Troubleshooting** section, then move to the **General Troubleshooting** section for further guidance.



Installation, operation, and maintenance must be performed by qualified personnel. Familiarization with and adherence to the National Electrical Code (NEC), the National Fire Protection Association (NFPA) standards, and to local codes are required. It is important to observe safety precautions to protect personnel from possible injury.

- Code requirements differ from state to state. Install equipment using qualified electricians in accordance with the applicable codes and ordinances in your area and in accordance with the NEC. All electrical connections should be made and maintained by a qualified or licensed electrician.
- Always disconnect electrical power at the fuse box or circuit breaker panel before handling electrical connections or performing maintenance on this unit. Allow the motor to come to a complete stop and wait three (3) minutes. This allows the capacitors to discharge any residual voltage.



- Wear safety glasses to inspect the equipment while it is running or while working on equipment.

Basic Troubleshooting

Motor shaft is not rotating or runs abnormally

- Verify that the pump should be running, based on the time of day and how you have the sequence of timers programmed in the pump.
- Verify that the motor is not paused.
- Check the circuit breaker for trips or accidental shutoff.
- Verify that the signal cable and electrical power leads are securely connected to the control connectors. Inspect for shorts, detached wiring, or loose connections.

Motor rattles or makes excessive noise

- Inspect the motor for accumulated dirt and debris, or other signs of damage.
- Inspect the motor for secure mounting to the system chassis.
- Inspect the screws on the User Interface Cover. Verify that they are securely tightened.
- Inspect the motor shaft; verify that the shaft is not bent and that the shaft spins freely in both directions.

General Troubleshooting

Symptom	Possible Cause	Corrective Action
Motor fails to start.	Incorrect voltage to the motor	Verify that the motor voltage to the terminals matches the nameplate voltage requirements.
	Improper terminal connections	Turn OFF electrical power. Verify that connections are per the terminal connection section of this manual.
Motor stalls during operation.	Overloaded motor	With electrical power disconnected, verify that the pump rotates freely.
	Low voltage	Verify that the motor voltage under load to the conduit box connection terminals matches the nameplate voltage requirements.
	Breaker trip	The interruption of electrical power due to a current breaker trip indicates a current overload to the circuit beyond the rating of the breaker(s). Use a qualified electrician to make sure the breaker(s) rating is properly sized to the motor current rating based on the National Electrical Code.
Motor vibrates or is excessively noisy.	Pump	Before taking any corrective actions, ensure that the electrical power is OFF . Check the pump to ensure it is properly connected to the motor shaft. Check the pump impeller for damage. Make sure there are no foreign objects inside pump fan.
	Motor base (if applicable)	Verify that the motor base (if applicable) is not cracked and that the four (4) mounting bolts are secured tightly.
Motor is not operating properly.	Electrical power	Check line voltage.
Motor does not start.	Over / under voltage	Check line voltage.

Fault Conditions

The pool pump motor is designed to protect itself in the event of a fault condition. Should the motor encounter a fault, the Error light on the integrated UI illuminates and the LCD displays basic information on the error.

E 0 – Motor Control Overcurrent (HW)

Motor phase current is the input current enabling the pump to run at or under a specified speed or torque. Phase current over the peak threshold will trigger an Overcurrent (HW) or an Overcurrent (SW) fault. The pump will shut down and restart automatically. Then, the motor will cycle through the Shutdown/Restart sequence several times to correct the fault condition. At the end of the sequence, if the fault has not corrected itself, the motor will not restart.

Overcurrent usually happens very quickly. In this case, the motor protects itself by shutting down immediately. The fault condition can be triggered by the motor, the control, or the pump system. The cause is likely a severe pump overload. There are a couple possibilities. (1) Unfiltered debris lodged in the pump needs to be removed. (2) The pump is binding and needs field service.

Press the **START/PAUSE** button to clear the fault from the LCD display. Then, press any **Speed** button to restart the motor. The Retry sequence will start over. If the fault continues to occur, contact your pool professional or a qualified electrician for service.

E 1 – Motor Control Low Voltage

The voltage to the motor/control terminals must be either 115 or 230 Vac for the 1.50 & 1.65 THP Dual Voltage models, or 230 Vac for the 2.25, 2.7, & 3.45 THP Single Voltage models, $\pm 10\%$, at 60 or 50 Hz. A sustained input voltage significantly below the nominal voltage will cause a Low Voltage trip to occur.

When the fault occurs, the pump will shut down and automatically restart when operating conditions are within specifications.

When the input voltage returns to a normal state, the fault automatically clears and the motor restarts. If the fault continues to occur after verifying input line voltage is correct, contact your pool professional or a qualified electrician for service.

E 2 – Motor Control High Voltage

The voltage to the motor/control terminals must be either 115 or 230 Vac for the 1.50 & 1.65 THP Dual Voltage models, or 230 Vac for the 2.25, 2.7, & 3.45 THP Single Voltage models, $\pm 10\%$, at 60 or 50 Hertz. A sustained input voltage significantly above the nominal voltage will cause a High Voltage trip to occur.

When the fault occurs, the pump will shut down and automatically restart when operating conditions are within specifications. The pump will cycle through the Shutdown/Restart sequence several times to correct the fault condition.

When the input voltage drops to a normal state, the fault automatically clears and the motor restarts. If the fault continues to occur after verifying input line voltage is correct, contact your pool professional or a qualified electrician for service.

E 4 – Motor Control Power Module Hot

The power module is an integrated circuit in the motor control. Software in the control continuously monitors the temperature of this component. If the temperature in the power module exceeds a specified threshold, the motor stops to prevent the power module from overheating and causing damage to the motor.

Neptune® 1.5, 1.65, 2.25, 2.7, & 3.45 THP Pool Pump Motor

The temperature of other parts of the motor control can also be elevated during operation and the control will attempt to reduce the temperature by reducing motor output power. If the control is unable to reduce the temperature enough by decreasing the output power, this or one of several other faults will be triggered and the motor will stop. After the system temperature returns to an acceptable level, the pump will automatically restart and the fault on the LCD display will be cleared.

E 5 – Motor Control Open Output Phase

An open phase indicates that one or more of the three phase lines between the motor and control is not connected securely, or that there is an open circuit in the motor winding phase. Output voltage in the control is not able to reach the motor. The pump cycles through the Shutdown/Restart sequence several times to correct the fault condition. If that is unsuccessful, the motor stops.

Press the **START/PAUSE** button to clear the fault from the LCD display. The Retry sequence will start over. Then, press any **Speed** button to restart the motor. If the fault continues to occur after verifying the wire connections, contact your pool professional or a qualified electrician for service.

E 7 – Motor Control Max Output Load

Max Output Load usually happens over an extended period of time. The motor becomes torque limited and, to protect itself, the motor tries to modify its operation to correct the problem. If the motor cannot back down far enough to relieve the torque issue, the motor shuts down.

Refer to **E 0** for possible corrective actions.

E 8 – Motor Control EE Failure

This fault indicates that an error occurred in the memory area of the chip used to store software information needed to run the motor. For some reason, the software was unable to read key values from memory.

E 9 – Motor Control Overcurrent (SW)

This is another type of overcurrent fault, similar to **E 0**, but uses a different detection method. Refer to **E 0** for a description and possible corrective actions.

E 11 – Motor Control Communication Lost

The motor and the system control unit (DI Board) are unable to communicate. When that happens, the pump shuts down.

Remove the UI Cover to the voltage compartments. Refer to **Step 1** in **Wire the Motor** on **page 10**. Verify that the wiring connectors on the DI Board in the Low Voltage Compartment are securely fastened. Replace the UI Cover. Press any **Speed** button to restart the motor. If the fault continues to occur after verifying the wire connections, contact your pool professional or a qualified electrician for service.

E 12 – UI Key Stuck

The **START/PAUSE** button is stuck. If that should happen, the motor shuts down. Press the **START/PAUSE** button to see if you can release it. If the fault continues to occur after verifying the wire connections, contact your pool professional or a qualified electrician for service.

E 16 – Motor Stalled

This fault indicates that the motor shaft is unable to turn. When the software detects this condition, the motor automatically shuts down and restarts. The pump cycles through the Shutdown/Restart sequence several times to correct the fault condition.

If the shaft is unable to turn, it may be caused by an accumulation of dirt or debris in or around the motor causing the impeller to jam. Refer to the **Maintenance** section on **page 48** for steps you can take.

Press the **START/PAUSE** button to clear the fault from the LCD display. The Retry sequence will start over. Then, press any **Speed** button to restart the motor. If the fault continues to occur after a maintenance inspection, contact your pool professional or a qualified electrician for service.

E 17 – Control Over Temperature

This is another type of circuitry over temperature fault, similar to **E 4**, but sourced from different part of the control. Refer to **E 4** for a description and possible corrective actions.

E 18 – Motor Control Hardware Fault (Opens/Shorts)

An internal hardware failure has occurred. This fault indicates a serious problem within the control system that cannot be fixed by the end-user. Contact your pool professional or a qualified electrician for service.

E 25 – Reset to Factory Settings

Pool settings stored in memory became corrupted. All values were automatically reset to the default factory settings. Any customized settings will have to be re-entered. This is an informational fault that is displayed only for a short time. After the message disappears from the UI, the motor/pump is ready to run using the default factory settings.

E 26 – Modbus Comm Lost

While operating in Remote Mode, the connection to the central controller was lost.

Remove the User Interface Cover to the voltage compartments. Refer to **Step 1** in **Wire the Motor** on **page 10**. Verify that the wiring connectors on the circuit board in the Low Voltage Compartment are securely fastened. Also, refer to the **RS-485 Port** on **page 38** and verify that all connections to the remote/central controller are made correctly. Replace the UI Cover and connect electrical power to the motor again. Attempt to reestablish communication with the central controller. If the fault continues to occur after verifying the wire connections, contact your pool professional or a qualified electrician for service.

E 27 – MC Comm Lost

This is another type of communication error between the motor and the system control unit (DI). Refer to **E 11** for a description and possible corrective actions.

E 29 – Limits profile is corrupt

This fault indicate that an error occurred in one of the memory areas of one or more of the system chips used to store motor control or user configurable parameters. For some reason, the software was unable to read the values from memory.

Power down the motor. Wait three (3) minutes. Then, power the motor up again. If the fault continues to occur after powering up the motor, contact your pool professional or a qualified electrician for service.

E 30 – Options profile is corrupt

This is another type of memory failure. Refer to **E 29** for a description and possible corrective actions.

E 31 – Power loss profile is corrupt

This is another type of memory failure. Refer to **E 29** for a description and possible corrective actions.

E 32 –Template Mismatch

This is another type of memory failure. Refer to **E 29** for a description and possible corrective actions.

E 33 – UI/DI Comm Lost

The User Interface and the system control unit (DI Board) are unable to communicate. **E 33** occurs if communication is properly established at power up, but then lost sometime later.

Remove the User Interface Cover to the voltage compartments. Refer to **Step 1** in **Wire the Motor** on **page 10**. Verify that the wiring connectors on the circuit board in the Low Voltage Compartment are securely fastened. Check connector **P2** on the DI Board in particular. Replace the UI Cover. Press any **Speed** button to restart the motor. If the fault continues to occur after verifying the wire connections, contact your pool professional or a qualified electrician for service.

E 34 – No DI at Power Up

This is another type of communication error. **E 34** can only occur when the unit is first powered up. Refer to **E 33** for a description and possible corrective actions.

Maintenance



Before performing any maintenance on the pump, disconnect electrical power. Allow the motor to come to a complete stop and wait three (3) minutes. This allows the bus capacitors in the control to discharge any residual voltage.

- Periodically inspect the installation. Check for dirt accumulation, unusual noises or vibration, overheating, worn or loose couplings, high motor amps, poor wiring or overheated connections, loose mounting bolts or guards, and worn motor starter contacts. Check all wiring harnesses and control connectors. Inspect for shorts, detached wiring, or loose connections.
- Remove any debris accumulation, particularly in and around vent openings by vacuuming. Dirt or debris accumulation can jam the impeller, cause motor overheating, and is also a fire hazard.
- **DO NOT** use solvents! Some solvents may attack motor insulation, finish, or bearing lubricants. Solvents are highly flammable.
- Ball bearing motors are permanently lubricated. No maintenance is required.

Lower Your Utility Costs

Your electric bill is based on the number of Kilowatts used in a typical billing cycle. Each Kilowatt is 1,000 watts. To calculate how much energy your current pool motor is using and to calculate the savings potential of your pool pump motor, visit our web site and use the [Pool Pump Savings Calculator](https://apps.nidec-motor.com/poolcalculator/).



<https://apps.nidec-motor.com/poolcalculator/>

The calculator uses US Dollars (USD) for savings calculation only. The calculator will show you how many hours to run your pump each day, along with the appropriate speed for maximum energy savings. Contact your utility company to determine peak demand times of day or the times of day during which higher utility costs are charged to the customer. Then, program your motor either not to run at all, or to run at very low RPMs during these periods.

Example Calculations

Note: By reducing your speed to 50% RPM, the horsepower requirement is reduced to 1/8th of the 100%. The calculation is as follows:

$$(50/100 * 50/100 * 50/100) = .125 \text{ or } 12.5\%$$

To run the pump at 30% RPM, the calculation is as follows:

$$(30/100 * 30/100 * 30/100) = 0.027 \text{ or } 2.7\%$$

That would be 2.7% of the previously used Max THP. Lower utility cost is a primary advantage of the Neptune® 1.5, 1.65, 2.25, 2.7, & 3.45 THP Variable Speed Pool Pump Motor. Try out the **Pool Pump Savings Calculator** to determine your energy savings by reducing the speed while enabling the proper amount of daily flow needed to filter your pool.

Default Settings

These are the factory default settings for each mode of operation. The default values listed below are based on AM/PM equivalents, not the 24H clock setting. You can reset the pool pump motor to the default settings by enabling **Reset To Factory** located in corresponding menu tree.

Note: Some of the screens appearing in the DOE Scheduling menu trees are not included in the tables below. For example, a screen may be a selector screen or a calculated value, but not a default setting. These are excluded.

DOE Features Enabled

Install Settings	Value	Units
Time of Day	-	
24H or AM/PM	AM/PM	
Pool Capacity	12,000	Gallons
Pump Capacity	70	GPM
DOE Speed 1	30	%
DOE Speed 2	50	%
DOE Speed 3	80	%
DOE Speed 4	100	%
Remote Control	Disabled	
Node ID	240	Numeric

My Pool Settings	Value	Units
Temp Unit	F	
Priming Duration	3	Minutes
Priming Speed	2850	RPM
Low Temp Monitor	Enable	
Low Temp Monitor	37°	F
Pump Off Time	Off	
Pump Off Time Start	12:00 AM	
Low Cost Time	Off	
Flow Adjustment	5	Numeric
Disable DOE	No	

Neptune® 1.5, 1.65, 2.25, 2.7, & 3.45 THP Pool Pump Motor

DOE Features Disabled

Since the motor/control ships with the DOE Features Enabled, the following menus, options and timers are not available until the DOE scheduling is disabled.

Note: Some of the screens appearing in the Manual Timer menu trees are not included in the tables below. For example, a screen may be a selector screen or a calculated value, but not a default setting. These are excluded.

Install Settings	Value	Units
Time of Day	-	
24H or AM/PM	AM/PM	
Remote Control	Disable	
Node ID	240	Numeric

My Pool Settings	Value	Units
Temp Unit	F	
Priming Duration	3	Minutes
Priming Speed	2850	RPM
Low Temp Monitor	Enable	
Low Temp Monitor	37°	F
Enable DOE	No	

Timer Settings	Value	Units
Timer 1 Start	8:00 AM	
Timer 1 Duration	2	Hours
Timer 1 Speed	3450	RPM
Timer 2 Start	10:00 AM	
Timer 2 Duration	10	Hours
Timer 2 Speed	1400	RPM
Timer 3 Start	8:00 PM	
Timer 3 Duration	2	Hours
Timer 3 Speed	2200	RPM

Timer Settings	Value	Units
Timer 4 Start*	12:00	
Timer 4 Duration*	0	Hours
Timer 4 Speed*	1000	RPM
Timer 5 Start*	12:00	
Timer 5 Duration*	0	Hours
Timer 5 Speed*	1000	RPM
Timer 6 Start*	12:00	
Timer 6 Duration*	0	Hours
Timer 6 Speed*	1000	RPM
Timer 7 Start*	12:00	
Timer 7 Duration*	0	Hours
Timer 7 Speed*	1000	RPM

*By default, **Timers 4 – 7** are deactivated. A **Duration of 0** deactivates the Timer.

Index

Note: The menu hierarchies in the index below are listed alphabetically, not sequentially.

Agency.....	8	Low Cost Time.....	25
Safety Standards.....	8	Low Temperature Monitor.....	23
Clean and Override Operations.....	35	Low Temperature Threshold.....	23
Default Settings.....	49	Priming Duration.....	23
Dimensions.....	4	Priming Speed.....	23
C-Flange.....	5	Pump Off Time Duration.....	24
Square Flange.....	4	Pump Off Time Start.....	25
Thru Bolt with Base.....	6	Reset To Factory Defaults.....	24
DOE Features Disabled.....	26	Temperature Unit.....	23
Install Settings.....	29	View Version Numbers.....	24
24H or AM/PM.....	29	DI Version.....	24
Remote Control.....	29	MC Version.....	24
Disable Remote Control.....	30	UI Version.....	24
Node ID.....	29	Enable Manual Timers.....	35
Time of Day.....	29	Environmental Requirements.....	41
My Pool Settings.....	30	Environmental/Ingress Protection.....	41
Enable DOE Scheduling.....	32	Ranges.....	41
Low Temperature Monitor.....	31	Hardware Protection.....	41
Low Temperature Threshold.....	31	Input.....	7
Priming Duration.....	30	Input Power.....	7
Priming Speed.....	30	Line Current.....	7
Reset To Factory Defaults.....	32	Line Voltage.....	7
Temperature Unit.....	30	Power Factor.....	7
View Version Numbers.....	31	Keypad Lockout.....	34
DI Version.....	31	Lock the Menus.....	34
MC Version.....	31	Unlock the Menus.....	34
UI Version.....	31	Maintenance.....	48
Timer Settings.....	32	Lower Your Utility Costs.....	48
DOE Features Enabled.....	15	Mechanical Requirements.....	41
Install Settings.....	18	Motor Protection.....	40
24H or AM/PM.....	18	Navigation Overview.....	13
Calculated Pool Capacity.....	19	Interface Buttons.....	14
Edit DOE Speeds.....	21	Quick Start Guide.....	14
DOE Speed 1.....	21	Operational States.....	34
DOE Speed 2.....	21	Override a Timer.....	33
DOE Speed 3.....	21	Pause Mode.....	33
DOE Speed 4.....	21	Run Mode.....	33
Pool Capacity.....	18	Standby Mode.....	33
Calculate.....	18	Pump Control via the DI Board.....	36
Average Pool Depth.....	19	Discrete Switch Inputs.....	36
Average Pool Length.....	19	Control Panel Connections.....	37
Average Pool Width.....	19	DI Board Connections.....	38
Pool Shape.....	19	RS-485 Port.....	38
Manual.....	18	Wire a Remote Connection.....	39
Pump Capacity.....	20	Rated Output.....	8
Remote Control.....	22	Wire the Auxiliary Load Relay.....	12
Disable Remote Control.....	22	Dual Voltage Models.....	12
Node ID.....	22	Single Voltage Models.....	12
Time of Day.....	18	Wire the Pool Pump Motor.....	10
My Pool Settings.....	22	AC Terminal Block.....	11
Disable DOE Scheduling.....	25		
Flow Adjustment.....	25		

Warranty Information

LIMITED WARRANTY

Nidec Motor Corporation (NMC) extends the following LIMITED WARRANTY to the purchaser and to its customers (collectively referred to as the "Purchaser") of the enclosed motor and components: the motor and components are free from defects in materials and workmanship under normal use, service and maintenance FOR A PERIOD OF 24 MONTHS FROM THE DATE OF ORIGINAL PURCHASE FROM NMC OR THE NMC DEALER/RETAILER, NOT TO EXCEED 36 MONTHS FROM THE DATE OF MANUFACTURE BY NMC. THE FOREGOING WARRANTY IS THE ONLY WARRANTY GIVEN AND NO OTHER WARRANTY IS PROVIDED, EXPRESS OR IMPLIED, INCLUDING WITHOUT LIMITATION, MERCHANTABILITY OR FITNESS FOR A PARTICULAR PURPOSE. Certain aspects of disclaimers are not applicable to consumer products, i.e., motor and components acquired by individuals and used for personal, family or household purposes (as distinguished from industrial or other purposes). Some states do not allow limitations on how long an implied warranty lasts, so the above limitation may not apply to you. This warranty gives you specific legal rights, and you may have other rights which vary from state to state.

Certain repairs or services are the responsibility of the Purchaser and the Purchaser is expected to pay for them. This warranty does not extend to any losses or damages due to misuse, accident, abuse, neglect, negligence, unauthorized modification or alteration, use beyond rated capacity, or improper installation, maintenance, application or use, including, without limitation, use in a manner contrary to the accompanying instructions or applicable codes.

If within thirty (30) days after Purchaser's discovery of any warranty defects within the above stated warranty period, Purchaser notifies NMC or the dealer from whom the motor was purchased in writing, NMC shall, at its option and as Purchaser's exclusive remedy, repair or replace or refund the purchase price for that portion of the motor and components found by NMC to be defective. Failure by Purchaser to give such written notice within the applicable time period shall be deemed an absolute and unconditional waiver of Purchaser's claim for such defects. Purchaser must write or call the dealer from whom the motor was purchased for directions regarding the shipment of the motor, with freight prepaid by the Purchaser, to an authorized service location for warranty service. If Purchaser is unable to contact the dealer to obtain sufficient instructions regarding the handling of the motor, Purchaser should write NMC at the address below, giving the motor model number, the dealer's name, address and number of dealer's invoice; and describing the nature of the alleged defect. Arrangements for warranty service will then be made by NMC. If the motor is damaged in transit, Purchaser should file a claim directly with the carrier.

IN NO EVENT, REGARDLESS OF THE FORM OF THE CLAIM OR CAUSE OF ACTION (WHETHER BASED IN CONTRACT, INFRINGEMENT, NEGLIGENCE, STRICT LIABILITY, OTHER TORT OR OTHERWISE), SHALL NIDEC'S LIABILITY TO PURCHASER OR ITS CUSTOMER EXCEED THE PRICE PAID BY PURCHASER FOR THE SPECIFIC MOTOR OR OTHER GOODS PROVIDED BY GIVING RISE TO THE CAUSE OF ACTION. IN NO EVENT SHALL NIDEC'S LIABILITY TO PURCHASER OR ITS CUSTOMER EXTEND TO INCLUDE INCIDENTAL CONSEQUENTIAL OR PUNITIVE DAMAGES. WITH RESPECT TO CONSUMER PRODUCTS, SOME STATES DO NOT ALLOW THE EXCLUSION OR LIMITATION OF INCIDENTAL OR CONSEQUENTIAL DAMAGES, SO THE ABOVE LIMITATION OR EXCLUSION MAY NOT APPLY TO YOU.

Notes

© 2023 Nidec Motor Corporation. All rights reserved. U.S. Motors® and Neptune® are trademarks of Nidec Motor Corporation.

For more information

8050 W. Florissant Avenue | St. Louis, MO 63136

Phone: 800-566-1418

FAX: 314-595-8922

<http://acim.nidec.com/motors/usmotors/industry-applications/pool-and-spa>

Nidec

NIDEC MOTOR CORPORATION